

2017
PRODUCT
GUIDE



Address » 42, Gwonseon-ro 668beon-gil, Gwonseon-gu, Suwon-si, Gyeonggi-do, Korea
Tel » +82-31-245-6388 Fax » +82-31-245-6386 E-mail » info@fivics.com



Follow us on Twitter!
<https://twitter.com/FIVICSARCHERY>



Like us on Facebook!
<https://www.facebook.com/fivics.korea>



Subscribe to us on YouTube!
<https://www.youtube.com/user/fivicskorea>

Note: At the time of production of our 2017 Product Guide, the bows, limbs, color options, and all other accessories shown, and the information contained, had been thoroughly checked for accuracy. However, in the event an error was made, Fivics reserves the right to notify our dealers and customers at its discretion. Additionally, Fivics reserves the rights to modify, change or discontinue products shown in this publication without notice. Before using bows and other archery equipment, read all safety guidelines and warnings in the owner's manual or Online at www.fivics.com.



For more information visit us online at
www.fivics.com

**FIVICS BOW
LIMITED LIFETIME WARRANTY**

Fivics recurve handles are guaranteed against manufacturing defects in materials and workmanship to the original owner for the life of the product.



FIVICS[®]
ARCHERY
Team

Thanks to our shooters in Rio, 2016

81shooters choose Fivics Saker Finger tabs from total 128shooters(63%)

It was our pleasure and we feel confidence what they chose Fivics high quality equipment from all around world.

We would like to say thanks to all of shooters.

We will do our best to support you and make you get good score thru high quality equipments.

Thank you very much!

TEAM FIVICS



128 shooters in Rio 2016,
81 top shooter's choice



CONTENTS

| | |
|----|------------------------------|
| 06 | FIVICS BOW TECHNOLOGY |
| 10 | LT RISER |
| 14 | TITAN X2 RISER |
| 16 | VELLATOR SRV RISER |
| 17 | VELLATOR 25" RISER |
| 18 | LIMBS |
| 20 | TITAN LIMBS |
| 22 | VELLATOR FOAM LIMBS |
| 23 | VELLATOR WOOD LIMBS |
| 24 | BOW SPECIFICATIONS |
| 26 | FIVICSARROWS |
| 28 | XQ-3.15 |
| 29 | TENPRO |
| 30 | MACH1 |
| 31 | ZEILO |
| 32 | MACH3 |
| 33 | NINJA |
| 36 | FIVICS ACCESSORIES |
| 38 | SIGHT |
| 40 | STABILIZER |
| 42 | OTHERS |
| 46 | FIVICS GEAR |
| 52 | TARGETS |



LIMBS FACTORY OF FIVICS

Since 2016, Fivics's limbs factory has been starting productions. Fivics has own lab testing room and long experiences of archery which never did before. Now, Fivics can apply their own dream and future in the new facility and makes possible of much better quality, innovative ideas on the limbs and most reliable price level.

Unlimited improvement

Fivics is only the one who can do endless challenge, make full passion like fire and make you "If Fivics, they can make new revolutionary idea"

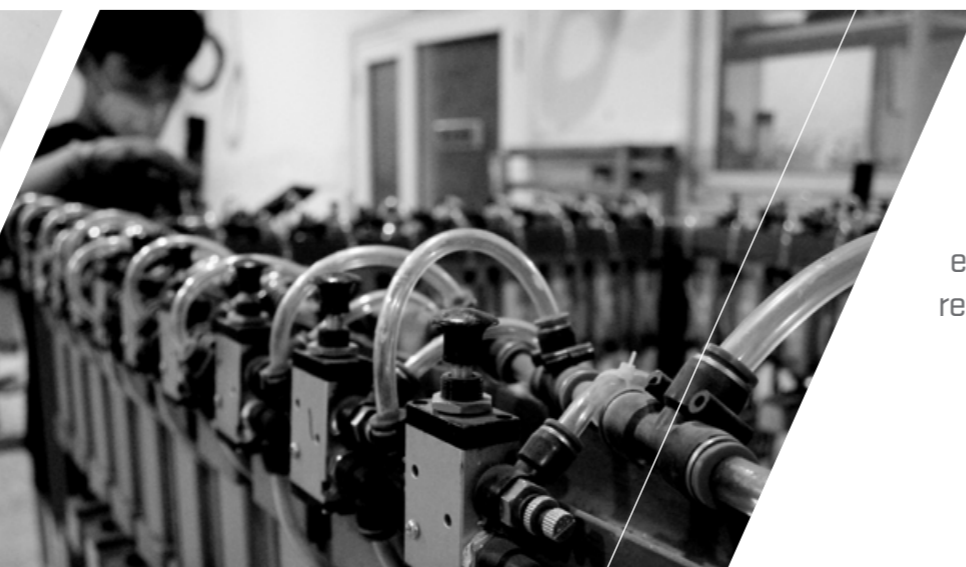

No one has done it yet, but it's worth doing. Fivics has developed new material and has advanced equipment by new and refresh idea toward archery.



FIVICS TECHNOLOGY

Abandon existing ways of thinking and promote new ideas with fresh senses. Even I won today, there is no way to win again tomorrow. Endless development can make Fivics alive and it is saying "Vitality"

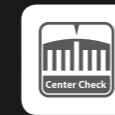

Center Check
New fivics center checking parts make you easy to adjust the center from the special designed scale.



Non Vibration
Patents limb pocket makes non vibration

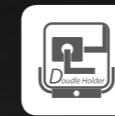

Double Holder
Double screws on the limbs pockets hold the limbs strongly



Screw joint
No more release of screws during shooting



Ergonomic Grip
comfortable grip and make your shoot clear



Strong Spine
enough to hold strong spine



Non Vibration
Patents limb pocket makes non vibration



Rubber Coated
Rubber coating makes easy to attach or detach

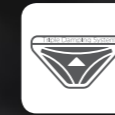

Triple Damping System
3ways of damping absorb vibration most efficiently



Double Damper
2ways of damping absorb vibration most efficiently



3K Technology
3K carbon is most strongest material for archery



Incert Damper
Strong outside, but inside with rubber to absorb vibration



Nano Tech
New nano technology is applied



Human engineering
Based on human, made for human



Absorption of vibration
More than 1,000 tests make the best absorption of vibration



Water proof
Perfect water proof for rainy shooting



UD Carbon
The best carbon material to be applied limbs

NEW TECHNOLOGY OF LT RISER

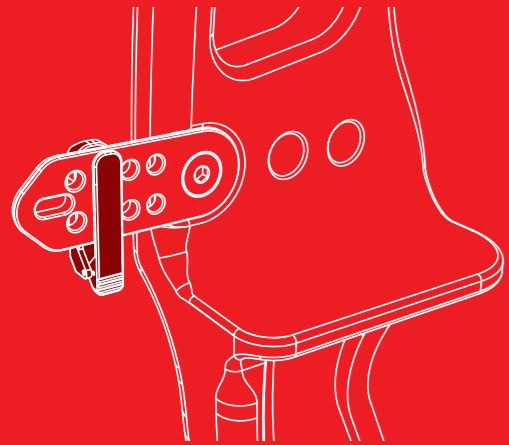

New designed clicker flat and make the best shooting chance.

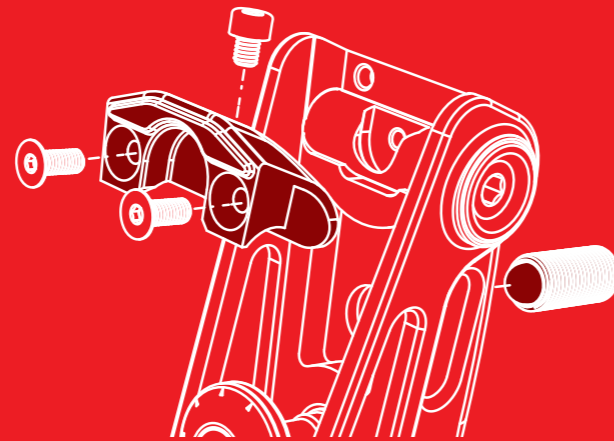

4 extra bolts are holding the limbs pocket and easy to adjust your limb center with easy way

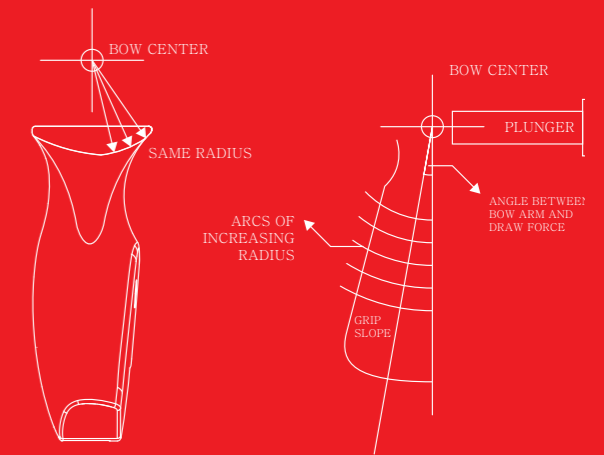

The best grip position give the best testing result
New desinged V shape of grips make efficient power

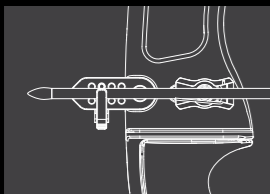

Special holes in the clicker flat shows what your arrow is straight or not from rest part

Existing clicker bolts, somtimes hides shooter's sight, but Fivics new clicker flat is different way, not to atache the bolt on the riser. So, it shows shooter's sight without hiding some bolt and easy to make your own bow.

Full aluminum make the strong dularbility.

Best grip angel

3 important points in grip system

1. The grip is located in bow center
2. The grip is located in angel between bow arm and draw force
3. The grip is located in arcs of increasing radius

Best grip postion shows the best test

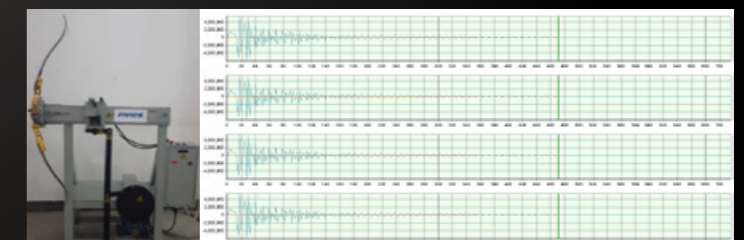

TITAN LT™



Anodized



Black Pink Blue Gold Red



HL0525 » TITAN LT RISER

- Superfine CNC milling
- Special unique designed wooden grip
- Slow production
- Perfect centroidal balance
- Flawless coating
- Deep color from anodizing
- Showy color from painting

PROCESSING » **CNC**
 WEIGHT » **1,315g(25")**
 MATERIAL » **AL 6061**
 TYPE » **RH/LH**
 GRIP » **Cherry Wood**
 COLOR » **Anodized**



RECURVE BOWS

TITAN X2™



PERFECT CENTROIDAL BALANCE



HL0525 » LT RISER

- Superfine CNC milling
- Special unique designed wooden grip
- Slow production
- Perfect centroidal balance
- Flawless coating
- Deep color from anodizing
- Showy color from painting

PROCESSING » CNC
 WEIGHT » 1,315g(25")
 MATERIAL » AL 6061
 TYPE » RH/LH
 GRIP » Cherry Wood
 COLOR » Anodized



RECURVE BOWS



**VELLATOR™
SRV**

HS0125 » VELLATOR SRV RISER

- Flawless coating
- Showy color from painting
- Perfect centroidal balance

PROCESSING » **CNC**
 WEIGHT » **1,260g**
 MATERIAL » **AL 6061**
 TYPE » **RH/LH**
 GRIP » **Plastic**
 COLOR » **Painted**



VELLATOR

**HV0225 » VELLATOR 25" RISER
 HV0223 » VELLATOR 23" RISER**

- The lightest weight
- Only 1,100grams
- Flawless coating
- Showy color from painting
- Perfect centroidal balance

PROCESSING » **Forged & CNC**
 WEIGHT » **1,100g(25")/1,070(23")**
 MATERIAL » **AL 6061**
 TYPE » **RH**
 GRIP » **Plastic**
 COLOR » **Anodized**
 LENGTHS » **23",25"**



RECURVE BOWS

RECURVE BOWS

TITAN

Unlimited improvement

Fivics is only the one who can do endless challenge, make full passion like fire and make you "If Fivics, they can make new revolutionary idea"



NEW TECHNOLOGY OF TITAN LIMBS

Since 2016, Fivics's limbs factory has been starting productions. Fivics has own lab testing room and long experiences of archery which never did before. Now, Fivics can apply their own dream and future in the new facility and makes possible of much better quality, innovative ideas on the limbs and most reliable price level.

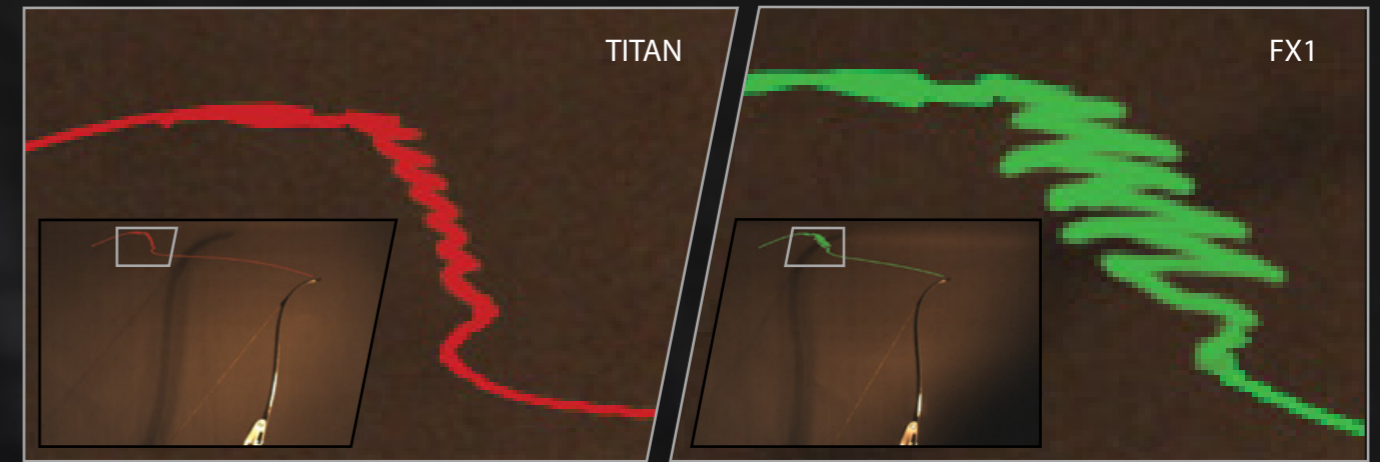

measurement with superhigh speed camera in 1/1000

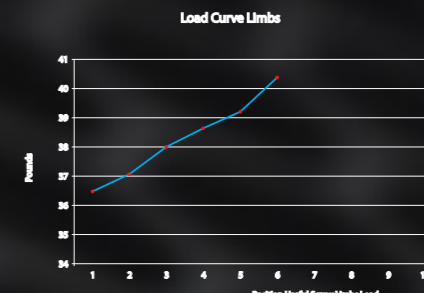
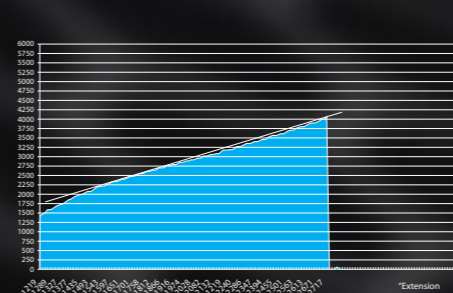
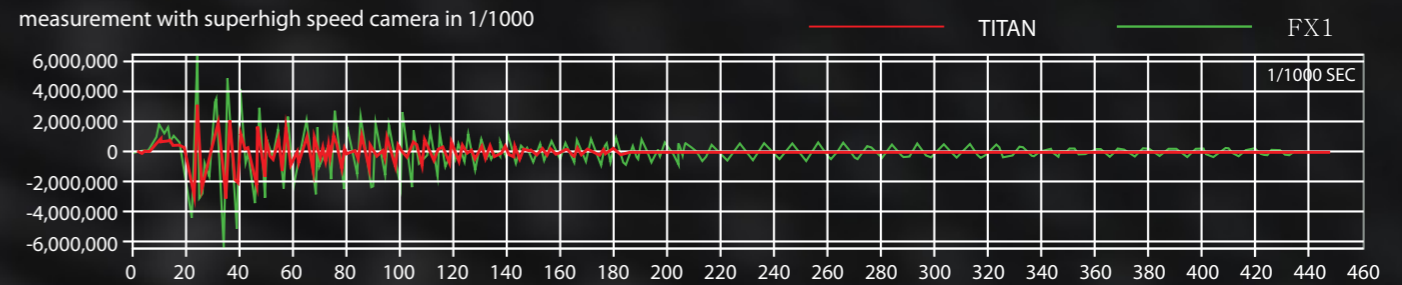

No one has done it yet, but it's worth doing. Fivics has developed new material and has advanced equipment by new and refresh idea toward archery.



TITAN

LTW05 » TITAN X2 WOOD CORE LIMBS

- Clear and powerful shooting
- New Material : **MONOCOQUE** UD carbon
- Light weight
- New designed tip part

MATERIAL » **Double angled Full Carbon**
 CORE » **Wood core**
 BOW LENGTH » **66",68",70"**
 DRAW WEIGHT(lbs.) » **32#~50#**

** Fivics's all limbs are installed to all Fivics's riser and others.*

Double angled Full Carbon
 Monocoque UD carbon
 High Quality Wood Core
 High Quality Wood Core
 Carbon U/D
 Double angled Full Carbon

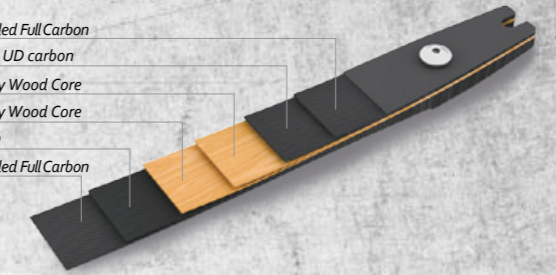

TITAN

LTF05 » TITAN X2 FOAM CORE LIMBS

- Clear and powerful shooting
- New Material : **MONOCOQUE** UD carbon
- Light weight
- New designed tip part

MATERIAL » **Double angled Full Carbon**
 CORE » **Foam core**
 BOW LENGTH » **66",68",70"**
 DRAW WEIGHT(lbs.) » **32#~50#**

** Fivics's all limbs are installed to all Fivics's riser and others.*

Double angled Full Carbon
 Monocoque UD carbon
 M-Foam Core
 M-Foam Core
 Carbon U/D
 Double angled Full Carbon

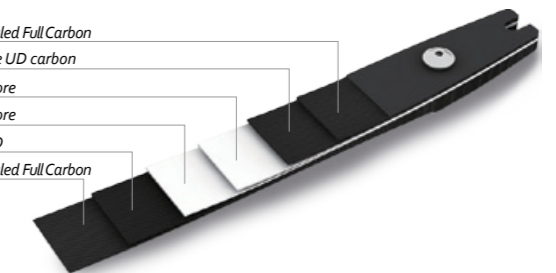

RECURVE BOWS

RECURVE BOWS



VELLATOR



LGF01 » VELLATOR FOAM LIMBS

- Foam core only
- Makes high speed arrow
- New designed tip

MATERIAL » **UD CARBON**
 CORE » **M-FOAM CORE**
 BOW LENGTH » **66",68",70"**
 DRAW WEIGHT(lbs.) » **22#-38#**

** Fivics's all limbs are installed to all Fivics's riser and others.*

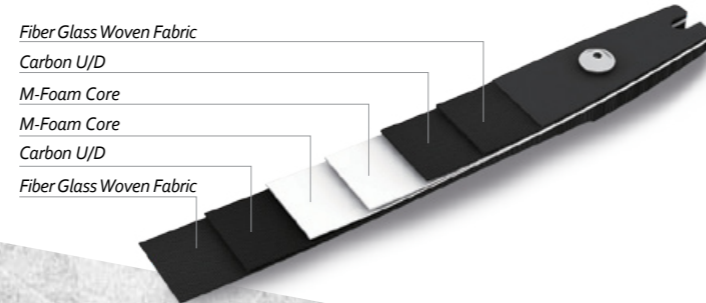

Fiber Glass Woven Fabric
 Carbon U/D
 M-Foam Core
 M-Foam Core
 Carbon U/D
 Fiber Glass Woven Fabric



VELLATOR



LVW02 » VELLATOR WOOD LIMBS

- Wood core only
- Makes high speed arrow
- New designed tip
- Crosse carbon applied

MATERIAL » **UD CARBON**
 CORE » **Wood**
 BOW LENGTH » **66",68",70"**
 DRAW WEIGHT(lbs.) » **22#-38#**

** Fivics's all limbs are installed to all Fivics's riser and others.*

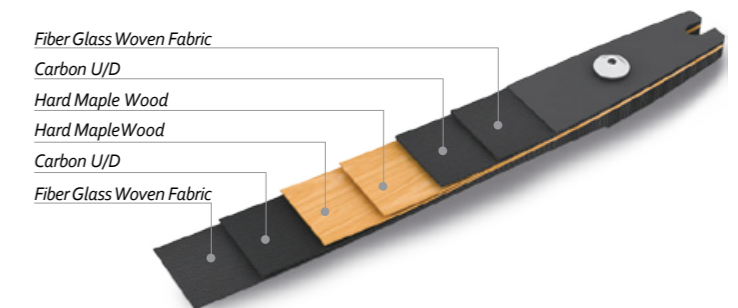

Fiber Glass Woven Fabric
 Carbon U/D
 Hard Maple Wood
 Hard Maple Wood
 Carbon U/D
 Fiber Glass Woven Fabric

RECURVE BOWS

RECURVE BOWS

RECURVE BOW



TITAN LT RISER

| LENGTHS | WEIGHT | MATERIAL | TYPE | COLOR (Painted) |
|---------|--------|----------------|---------|--------------------------|
| 25" | 1,260g | Aluminum(6061) | RH / LH | Black, Blue, Red, Yellow |

TITAN X2 RISER

| LENGTHS | WEIGHT | MATERIAL | TYPE | COLOR (Anodized & Painted) |
|---------|--------|----------------|---------|--|
| 25" | 1,315g | Aluminum(6061) | RH / LH | Anodized Black, Pink, Blue, Gold, Red Painted White, Yellow |
| 27" | 1,330g | | RH / LH | |

VELLATOR SRV RISER

| LENGTHS | WEIGHT | MATERIAL | TYPE | COLOR (Painted) |
|---------|--------|----------------|---------|--------------------------|
| 25" | 1,260g | Aluminum(6061) | RH / LH | Black, Blue, Red, Yellow |

VELLATOR RISER

| LENGTHS | WEIGHT | MATERIAL | TYPE | COLOR (Anodized) |
|---------|--------|----------------|------|---|
| 23" | 1,060g | Aluminum(6061) | RH | Black, Silver, Brown, Blue, Red, Pink, Gold |
| 25" | 1,100g | | | |

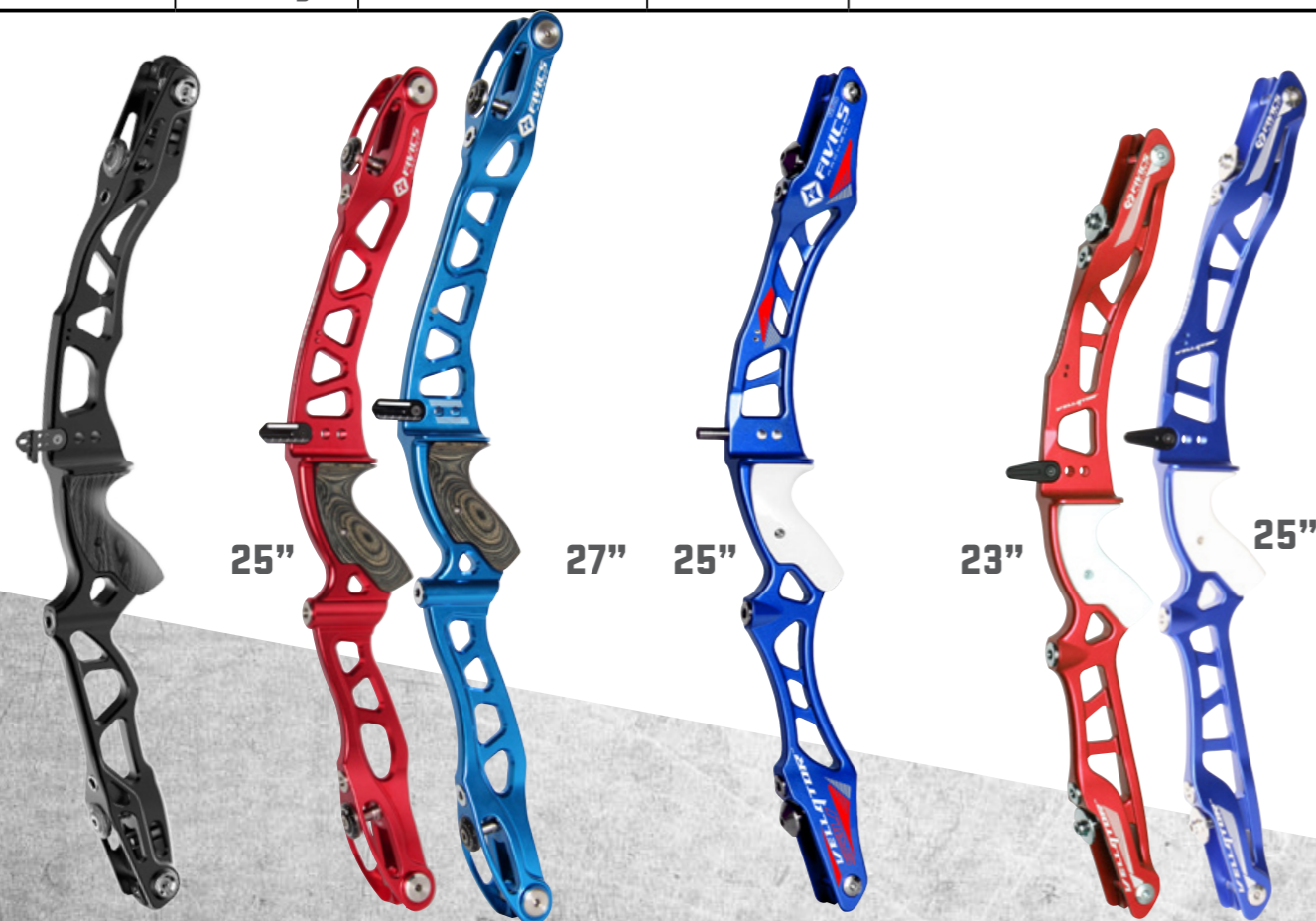

25"

27"

25"

23"

25"

TITAN LT

TITAN X2

VELLATOR SRV

VELLATOR

TITAN WOOD CORE LIMBS

| MATERIAL | DRAW WEIGHT (lbs.) | LENGTHS |
|----------------------------------|--------------------|---------------|
| Wood / Double angled Full Carbon | 32# ~ 50# | 66", 68", 70" |

TITAN FOAM CORE LIMBS

| MATERIAL | DRAW WEIGHT (lbs.) | LENGTHS |
|----------------------------------|--------------------|---------------|
| Foam / Double angled Full Carbon | 32# ~ 50# | 66", 68", 70" |

VELLATOR FOAM CORE LIMBS

| MATERIAL | DRAW WEIGHT (lbs.) | LENGTHS |
|------------------|--------------------|---------------|
| Foam / UD Carbon | 22# ~ 38# | 66", 68", 70" |

VELLATOR WOOD CORE LIMBS

| MATERIAL | DRAW WEIGHT (lbs.) | LENGTHS |
|------------------|--------------------|---------------|
| Wood / UD Carbon | 22# ~ 38# | 66", 68", 70" |



TITAN WOOD

TITAN FOAM

VELLATOR FOAM

VELLATOR WOOD

BEST QUALITY FIVICS ARROWS

Design your shooting !!

Challenge beyond limited record



XQ-3.15™

ARNX001 » XQ-3.15 ARROW (Recurve & Compound)

Excellent in grouping of arrows with stability and accuracy

XQ-3.15, it took more than 3 years testing and developing by Korean national team member, Mr. Jang Young Ho and during testing, we Fivics found the perfect inner diameter to make stability and accuracy between point and shaft, **ϕ 3.15**

Uniform production makes equal specification and has outstanding arrow grouping and reducing arrow damage rate which is always troublesome of carbon arrow's natural.

Fivics also found new material for XQ-3.15 arrow and it is MC 46ton carbon which has strong points in accuracy and durability of epoxy resin.

We, Fivics, hereby can tell you that XQ-3.15 is perfect for Archery competition arrow due to these outstanding reasons.

- Advanced Technology, Extreme Accuracy.
- Straightness: ± 0.001".
- Weight tolerance: ± 1.0 grains.
- Spine selection tolerance: ± 0.002".

Stainless Steel Target Point

Q1/120 (400-450)
Q2/120 (500-650)
Q3/120(700-1000)



Pin Nock Adapter

Q1 (400-450)
Q2(500-650)
Q3(700-1000)



FIVICS Pin Nock (PI-N)



| Size | Legnth | Weight(Grain) | Diameter | Spine | Qty | Recommended Point Weight ange |
|------|--------|---------------|----------|-------|--------|-------------------------------|
| 400 | 32 | 268.6 | 5.22 | 400 | 12pack | Q1/120g |
| 450 | 32 | 243.6 | 5.09 | 450 | 12pack | |
| 500 | 32 | 225.4 | 4.95 | 500 | 12pack | Q2/120g |
| 550 | 32 | 214 | 4.9 | 550 | 12pack | |
| 600 | 32 | 202.6 | 4.8 | 600 | 12pack | Q3/120g |
| 650 | 32 | 192.4 | 4.73 | 650 | 12pack | |
| 700 | 32 | 181.6 | 4.62 | 700 | 12pack | Q3/120g |
| 750 | 32 | 177.4 | 4.6 | 750 | 12pack | |
| 800 | 32 | 167.6 | 4.59 | 800 | 12pack | Q3/120g |
| 850 | 32 | 161.3 | 4.52 | 850 | 12pack | |
| 900 | 32 | 156.7 | 4.48 | 900 | 12pack | Q3/120g |
| 1000 | 32 | 147.5 | 4.41 | 1000 | 12pack | |

TEN Pro

ARTR001 » TENPRO

Strong durability against wind due to 30ton of carbon applied.

New Tenpro is one of ultra slim arrow designed for recurve shooters. There are lots of functions of arrows in Tenpro, but the most important thing is that it has a strong fortress in the middle part and it allows arrow goes straight way. And also, its own ultra slim shape can reduce the wind and very useful and optimized for FITA, NAA and NFAA long field shooting.

30tons of carbon makes extreme speed, strength and consistence in shooting and there speedy restoration from multi-shooting.

- Advanced Technology, Extreme Accuracy.
- Straightness: ± 0.002".
- Weight tolerance: ± 1.0 grains.
- Spine selection tolerance: ± 0.002".

Stainless Steel Target Point

T1/120 (300)
T2/120 (400-450)
T3/120 (500-550)
T4/120 (600-800)
T5/120 (900-1200)



Pin Nock Adapter

T1 (300)
T2 (400-450)
T3 (500-550)
T4 (600-800)
T5 (900-1200)



FIVICS Pin Nock (PI-N)



| Size | Legnth | Weight(Grain) | Diameter | Spine | Qty | Recommended Point Weight ange |
|------|--------|---------------|----------|-------|---------|-------------------------------|
| 300 | 32 | 397.6 | 6.3 | 300 | 12/pack | T1/120g |
| 400 | 32 | 335.6 | 5.98 | 400 | 12pack | T2/120g |
| 450 | 32 | 302.6 | 5.79 | 450 | 12pack | |
| 500 | 32 | 279 | 5.63 | 500 | 12pack | T3/120g |
| 550 | 32 | 260.5 | 5.55 | 550 | 12pack | |
| 600 | 32 | 250.1 | 5.45 | 600 | 12pack | T4/120g |
| 650 | 32 | 236.4 | 5.4 | 650 | 12pack | |
| 700 | 32 | 231.7 | 5.38 | 700 | 12pack | T4/120g |
| 800 | 32 | 211.4 | 5.22 | 800 | 12pack | |
| 900 | 32 | 194.5 | 5.1 | 900 | 12pack | T5/120g |
| 1000 | 32 | 189.2 | 5.09 | 1000 | 12pack | |
| 1100 | 32 | 171.5 | 4.96 | 1100 | 12pack | T5/120g |
| 1200 | 32 | 162.2 | 4.9 | 1200 | 12pack | |

ARROW & TARGET

ARROW & TARGET

MACH1

MN1S001 » MACH1 ARROW

Strong durability against wind due to 24ton of carbon applied.

New Mach1 is one of ultra slim arrow designed for recurve shooters. There are lots of functions of arrows in Mach1, but the most important thing is that it has a strong fortress in the middle part and it allows arrow goes straight way.

24tons of carbon makes extreme speed, strength and consistence in shooting and there speedy restoration from multi-shooting.

- Advanced Technology, Extreme Accuracy.
- Straightness: $\pm 0.002''$.
- Weight tolerance: ± 1.0 grains.
- Spine selection tolerance: $\pm 0.0025''$.

Stainless Steel Target Point

- M1/120 (500-700)
- M2/120 (800-1000)
- M3/120 (1100-1500)



Pin Nock Adapter

- M1(500-700)
- M2(800-1000)
- M3(1100-1500)



FIVICS Pin Nock (PI-N)



| Size | Legnth | Weight(Grain) | Diameter | Spine | Qty | Recommended Point Weight ange |
|------|--------|---------------|----------|-------|---------|-------------------------------|
| 500 | 31 | 252.5 | 5.89 | 500 | 12 pack | M1/110-120g |
| 600 | 31 | 216 | 5.68 | 600 | 12 pack | M1/110-120g |
| 700 | 31 | 201.4 | 5.58 | 700 | 12 pack | M1/110-120g |
| 800 | 31 | 186.5 | 5.48 | 800 | 12 pack | M2/110-120g |
| 900 | 31 | 179 | 5.43 | 900 | 12 pack | M2/110-120g |
| 1000 | 31 | 159.8 | 5.32 | 1000 | 12 pack | M3/110-120g |
| 1100 | 31 | 154.3 | 5.22 | 1100 | 12 pack | M3/110-120g |
| 1200 | 31 | 141 | 5.2 | 1200 | 12 pack | M3/110-120g |
| 1300 | 31 | 129 | 5.18 | 1300 | 12 pack | M3/110-120g |
| 1400 | 31 | 127 | 5.11 | 1400 | 12 pack | M3/110-120g |
| 1500 | 31 | 124 | 5.05 | 1500 | 12 pack | M3/110-120g |

ZEILO

ARZI001 » ZEILO (Intermediate)

ZEILO is the target arrow for youths.

NEW cross weave of pure carbon layer gives it's unequaled strength, even on lightweight pure carbon arrows. This cross-woven method of construction is proven to deliver exceptional strength without adding weight.

- Advanced Technology, Extreme Accuracy.
- Straightness: $\pm 0.002''$.
- Weight tolerance: ± 1.0 grains.
- Spine selection tolerance: $\pm 0.0025''$.

Stainless Steel Target Point

- 120 (500-1500)
- 110 (500-1500)



Pin Nock Adapter SI-1000



FIVICS Pin Nock (PI-N)



| Shaft Size | Qty | ShWeight (Grain) | Spine | Recommended Point Weight Range |
|------------|---------|------------------|-------|--------------------------------|
| 500 | 12 pack | 9.22 | 500 | 110g / 120g |
| 600 | 12 pack | 8.76 | 600 | 110g / 120g |
| 700 | 12 pack | 8.18 | 700 | 110g / 120g |
| 800 | 12 pack | 7.61 | 800 | 110g / 120g |
| 900 | 12 pack | 7.26 | 900 | 110g / 120g |
| 1000 | 12 pack | 6.97 | 1000 | 110g / 120g |
| 1100 | 12 pack | 6.72 | 1100 | 110g / 120g |
| 1200 | 12 pack | 5.59 | 1200 | 110g / 120g |
| 1300 | 12 pack | 6.54 | 1300 | 110g / 120g |
| 1400 | 12 pack | 6.26 | 1400 | 110g / 120g |
| 1500 | 12 pack | 6.07 | 1500 | 110g / 120g |

ARROW & TARGET

ARROW & TARGET



MACH3

ARMC001 » MACH3 ARROW

Beginner **Carbon** Arrow

Size : 400/500/600/700/800/900/1000/1100/1300/1500/1800(11 kinds of spines)

Shaft only : one dozen/12pcs

Finished arrow : one dozen/12pcs = shaft + 1.65" vanes + In-nock + break-off point

Straightness: ± 0.004"

MACH TARGET POINTS

90-100g



Vanes

1.65"



In Nock



| Shaft Size | Qty | Stock Lenth inch | Spine | Point Weight |
|------------|---------|------------------|-------|--------------|
| 400 | 12 pack | 33" | 500 | 90-100g |
| 500 | 12 pack | 33" | 500 | 90-100g |
| 600 | 12 pack | 33" | 600 | 90-100g |
| 700 | 12 pack | 33" | 700 | 90-100g |
| 800 | 12 pack | 33" | 800 | 90-100g |
| 900 | 12 pack | 33" | 900 | 90-100g |
| 1000 | 12 pack | 30" | 1000 | 90-100g |
| 1100 | 12 pack | 30" | 1100 | 90-100g |
| 1300 | 12 pack | 30" | 1300 | 90-100g |
| 1500 | 12 pack | 30" | 1500 | 90-100g |
| 1800 | 12 pack | 30" | 1800 | 90-100g |



NINJA

ARNN001 » NINJA ARROW

Beginner **Carbon Composite** Arrow

Size : 400/500/600/700/800/900/1000/1100/1300/1500/1800(11 kinds of spines)

Shaft only : one dozen/12pcs

Finished arrow : one dozen/12pcs = shaft + 1.65" vanes + In-nock + break-off point

Straightness: ± 0.006"

MACH TARGET POINTS

90-100g



Vanes

1.65"



In Nock



| Shaft Size | Qty | Stock Lenth inch | Spine | Point Weight |
|------------|---------|------------------|-------|--------------|
| 400 | 12 pack | 33" | 500 | 70-80g |
| 500 | 12 pack | 33" | 500 | 70-80g |
| 600 | 12 pack | 33" | 600 | 70-80g |
| 700 | 12 pack | 33" | 700 | 70-80g |
| 800 | 12 pack | 33" | 800 | 70-80g |
| 900 | 12 pack | 33" | 900 | 70-80g |
| 1000 | 12 pack | 30" | 1000 | 70-80g |
| 1100 | 12 pack | 30" | 1100 | 70-80g |
| 1300 | 12 pack | 30" | 1300 | 70-80g |
| 1500 | 12 pack | 30" | 1500 | 70-80g |
| 1800 | 12 pack | 30" | 1800 | 70-80g |

ARROW & TARGET

ARROW & TARGET

XQ-3.15

| Bow Draw Weight | 23" | 24" | 25" | 26" | 27" | 28" | 29" | 30" | 31" | 32" | 33" |
|-----------------|--------|--------|--------|--------|--------|--------|--------|--------|--------|-------|-------|
| 13-15 lbs. | | | | | | | | XQ1000 | XQ1000 | XQ900 | XQ900 |
| 16-18 lbs. | | | | | | | XQ1000 | XQ1000 | XQ900 | XQ900 | XQ850 |
| 19-21 lbs. | | | | | | XQ1000 | XQ1000 | XQ900 | XQ900 | XQ850 | XQ800 |
| 22-24 lbs. | | | | | XQ1000 | XQ1000 | XQ900 | XQ900 | XQ850 | XQ800 | XQ750 |
| 25-27 lbs. | | | | XQ1000 | XQ1000 | XQ900 | XQ900 | XQ850 | XQ800 | XQ750 | XQ700 |
| 28-30 lbs. | | | XQ1000 | XQ1000 | XQ900 | XQ900 | XQ850 | XQ800 | XQ750 | XQ700 | XQ650 |
| 31-33 lbs. | | XQ1000 | XQ1000 | XQ900 | XQ900 | XQ850 | XQ800 | XQ750 | XQ700 | XQ650 | XQ600 |
| 34-36 lbs. | XQ1000 | XQ1000 | XQ900 | XQ900 | XQ850 | XQ800 | XQ750 | XQ700 | XQ650 | XQ600 | XQ550 |
| 37-39 lbs. | XQ1000 | XQ900 | XQ900 | XQ850 | XQ800 | XQ750 | XQ700 | XQ650 | XQ600 | XQ550 | XQ500 |
| 40-42 lbs. | XQ900 | XQ900 | XQ850 | XQ800 | XQ750 | XQ700 | XQ650 | XQ600 | XQ550 | XQ500 | XQ450 |
| 43-45 lbs. | XQ900 | XQ850 | XQ800 | XQ750 | XQ700 | XQ650 | XQ600 | XQ550 | XQ500 | XQ450 | XQ400 |
| 46-48 lbs. | XQ850 | XQ800 | XQ750 | XQ700 | XQ650 | XQ600 | XQ550 | XQ500 | XQ450 | XQ400 | |
| 49-51 lbs. | XQ800 | XQ750 | XQ700 | XQ650 | XQ600 | XQ550 | XQ500 | XQ450 | XQ400 | | |
| 52-54 lbs. | XQ750 | XQ700 | XQ650 | XQ600 | XQ550 | XQ500 | XQ450 | XQ400 | | | |
| 54-56 lbs. | XQ700 | XQ650 | XQ600 | XQ550 | XQ500 | XQ450 | XQ400 | | | | |
| 57-59 lbs. | XQ650 | XQ600 | XQ550 | XQ500 | XQ450 | XQ400 | | | | | |

TENPRO | MACH1 | ZEILO

TP= TENPRO MA=MACH1 ZL= ZEILO

| Bow Draw Weight | 23" | 24" | 25" | 26" | 27" | 28" | 29" | 30" | 31" | 32" | 33" |
|-----------------|----------------------------|----------------------------|----------------------------|----------------------------|----------------------------|----------------------------|----------------------------|----------------------------|---------------------------|-------------------------|-------------------------|
| 20-lbs. | MA1500 ZL1500 | MA1500 ZL1500 | MA1500 ZL1500 | MA1400 ZL1400 | MA1300 ZL1300 | MA1200 ZL1200 | TP1200 MA1200 ZL1100 | TP1100 MA1100 ZL1000 | TP1000 MA1000 ZL900 | TP900 MA900 ZL900 | TP800 MA800 ZL800 |
| 22-lbs. | MA1500 ZL1500 | MA1500 ZL1500 | MA1400 ZL1400 | MA1300 ZL1300 | MA1200 ZL1200 | TP1200 MA1200 ZL1100 | TP1100 MA1100 ZL1000 | TP1000 MA1000 ZL900 | TP900 MA900 ZL900 | TP800 MA800 ZL800 | TP800 MA800 ZL800 |
| 24-lbs. | MA1500 ZL1500 | MA1400 ZL1400 | MA1300 ZL1300 | MA1200 ZL1200 | TP1200 MA1200 ZL1100 | TP1100 MA1100 ZL1000 | TP1000 MA1000 ZL900 | TP900 MA900 ZL900 | TP800 MA800 ZL800 | TP800 MA800 ZL800 | TP700 MA700 ZL700 |
| 26-lbs. | MA1400 ZL1400 | MA1300 ZL1300 | MA1200 ZL1200 | MA1200 ZL1100 | MA1100 ZL1000 | MA1000 ZL900 | MA900 ZL900 | MA800 ZL800 | MA800 ZL800 | MA700 ZL700 | MA700 ZL700 |
| 28-lbs. | MA1300 ZL1300 | MA1200 ZL1200 | TP1200 MA1200 ZL1100 | TP1100 MA1100 ZL1000 | TP1000 MA1000 ZL900 | TP900 MA900 ZL900 | TP800 MA800 ZL800 | TP800 MA800 ZL800 | TP700 MA700 ZL700 | TP700 MA700 ZL700 | TP650 MA600 ZL600 |
| 30-lbs. | MA1200 ZL1200 | TP1200 MA1200 ZL1100 | TP1100 MA1100 ZL1000 | TP1000 MA1000 ZL900 | TP900 MA900 ZL900 | TP800 MA800 ZL800 | TP800 MA800 ZL800 | TP700 MA700 ZL700 | TP700 MA700 ZL700 | TP650 MA600 ZL600 | TP600 MA600 ZL600 |
| 32-lbs. | TP1200 MA1200 ZL1100 | TP1100 MA1100 ZL1000 | TP1000 MA1000 ZL900 | TP900 MA900 ZL900 | TP800 MA800 ZL800 | TP800 MA800 ZL800 | TP700 MA700 ZL700 | TP700 MA700 ZL700 | TP650 MA600 ZL600 | TP600 MA600 ZL600 | TP550 MA500 ZL500 |
| 34-lbs. | TP1100 MA1100 ZL1000 | TP1000 MA1000 ZL900 | TP900 MA900 ZL900 | TP800 MA800 ZL800 | TP800 MA800 ZL800 | TP700 MA700 ZL700 | TP700 MA700 ZL700 | TP650 MA600 ZL600 | TP600 MA600 ZL600 | TP550 MA500 ZL500 | TP500 MA500 ZL500 |
| 36-lbs. | TP1000 MA1000 ZL900 | TP900 MA900 ZL900 | TP800 MA800 ZL800 | TP800 MA800 ZL800 | TP700 MA700 ZL700 | TP700 MA700 ZL700 | TP650 MA600 ZL600 | TP600 MA600 ZL600 | TP550 MA500 ZL500 | TP500 MA500 ZL500 | TP450 |
| 38-lbs. | TP900 MA900 ZL900 | TP800 MA800 ZL800 | TP800 MA800 ZL800 | TP700 MA700 ZL700 | TP700 MA700 ZL700 | TP650 MA600 ZL600 | TP600 MA600 ZL600 | TP550 MA500 ZL500 | TP500 MA500 ZL500 | TP450 | TP400 |
| 40-lbs. | TP800 MA800 ZL800 | TP800 MA800 ZL800 | TP700 MA700 ZL700 | TP700 MA700 ZL700 | TP650 MA600 ZL600 | TP600 MA600 ZL600 | TP550 MA500 ZL500 | TP500 MA500 ZL500 | TP450 | TP400 | TP400 |
| 42-lbs. | TP800 MA800 ZL800 | TP700 MA700 ZL700 | TP700 MA700 ZL700 | TP650 MA600 ZL600 | TP600 MA600 ZL600 | TP550 MA500 ZL500 | TP500 MA500 ZL500 | TP450 | TP400 | TP400 | TP300 |
| 44-lbs. | TP700 MA700 ZL700 | TP700 MA700 ZL700 | TP650 MA600 ZL600 | TP600 MA600 ZL600 | TP550 MA500 ZL500 | TP500 MA500 ZL500 | TP450 | TP400 | TP400 | TP300 | TP300 |
| 46-lbs. | TP700 MA700 ZL700 | TP650 MA600 ZL600 | TP600 MA600 ZL600 | TP550 MA500 ZL500 | TP500 MA500 ZL500 | TP450 | TP400 | TP400 | TP300 | TP300 | |
| 48-lbs. | TP650 MA600 ZL600 | TP600 MA600 ZL600 | TP550 MA500 ZL500 | TP500 MA500 ZL500 | TP450 | TP400 | TP400 | TP300 | TP300 | | |
| 50-lbs. | TP600 ZL600 | TP550 ZL500 | TP500 ZL500 | TP450 | TP400 | TP400 | TP300 | TP300 | | | |
| 52-lbs. | TP550 ZL500 | TP500 ZL500 | TP450 | TP400 | TP400 | TP300 | TP300 | | | | |
| 54-lbs. | TP500 ZL500 | TP450 | TP400 | TP400 | TP300 | TP300 | | | | | |
| 56-lbs. | TP450 | TP400 | TP400 | TP300 | TP300 | | | | | | |

NC001S FIVICS Pin Nock(S)
NC001L FIVICS Pin Nock(L)

This universal pin nock fits all standard pin nock adapters. It is made from a durable polycarbonate material that performs shot after shot.

Size: S / L

Color:



Available in two size: #1 fits 12-18 strand strings
#2 fits 20-24 strand strings

AC01F » EZ FLETCHER

- EZ Fletcher is designed for putting vanes on a shaft very easily.
- automatic shaft holding system,
- angle control system
- magnetic system
- detailed adjustment system

FEATURE
MATERIAL : Aluminum
SIZE : 124 x 124 x 220
COLOR : Black



ARROW & TARGET

ARROW & TARGET



New recurve sight, FV-300

8pcs of rails inside of head parts hold all surface of sight and make strong stability. Accuracy adjustment function make better movement compared to Wormgear and extra dampers and weights reduce the vibration.

FULL POWER AHEAD

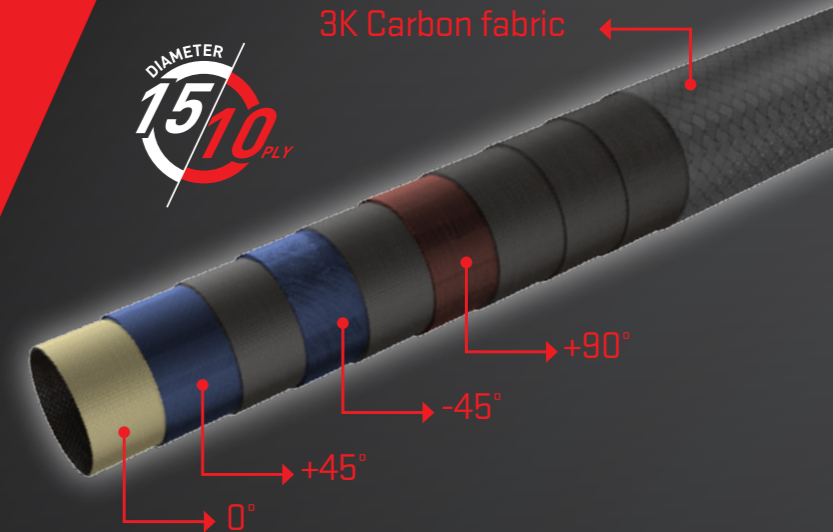
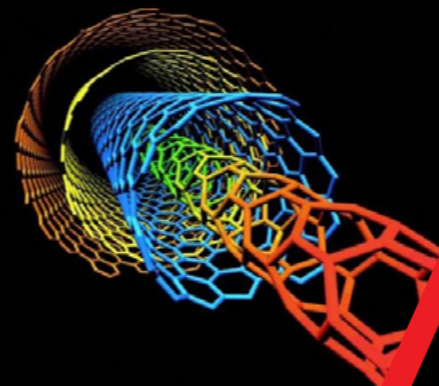

FIVICS STABILIZERS



New products, Phoenix1500D has unique extender system which is not existed and improved more on specially, joint failure part between riser and extender parts from other brands. High density carbon is included in aluminum construction and it prevents joint failure issue and reduces vibration.

Phoenix1500D has 15diameter with 10PLY carbon pipe and strong accuracy against wind. Even it has thin diameter, but due to laminated structure, it makes possible to reduce low vibration with short wave.

Fivics has developed a carbon nano-tube to apply with nano carbon stabilizer. CNT(carbon nanotube) is still invested by Fivics and we have made Non conjugated Polymer, carbon tube - epoxy complex and this technology makes 30% more stronger strength inside of carbon.

BEST QUALITY FIVICS ACCESSORIES



FIVICS ACCESSORIES



FV-300 » FV-300 SIGHT

- Designed for Olympic style / recurve bows
- Special designed weight and damper are excluded, but you can attach
- VTS (Variable Tension System)
- elevation travel tension adjustment

SIZE » **Extention 9"**
 TYPE » **RH /LH**
 MATERIAL » **Aluminum, Carbon**

NEW



FV-150S » FV-150S SIGHT

- Designed for Olympic style / recurve bows
- Special designed weight and damper are excluded, but you can attach

SIZE » **Extention 8"**
 TYPE » **RH /LH**
 MATERIAL » **Aluminum, Carbon**

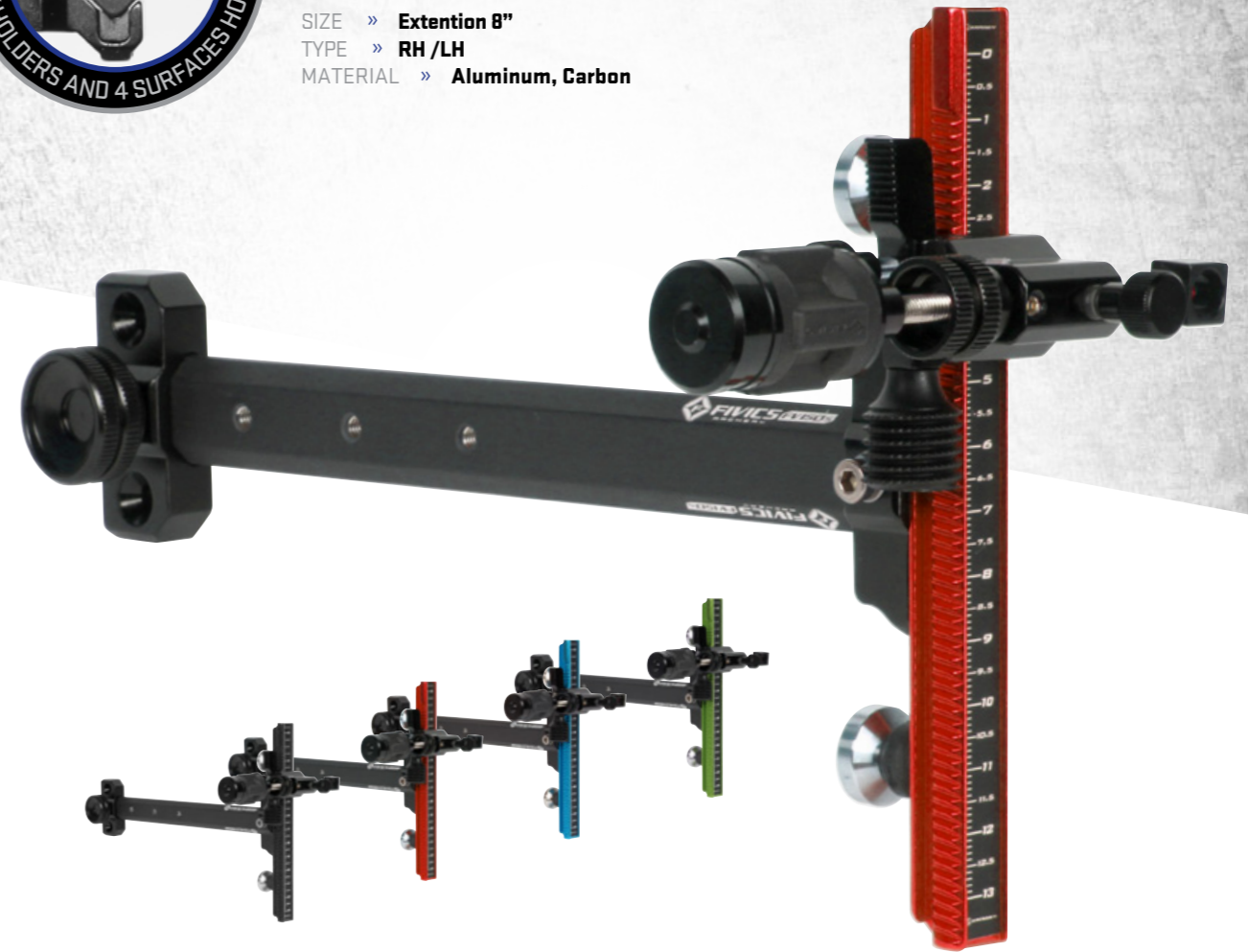

ACCESSORIES

ACCESSORIES

SGP01 » SIGHT PIN (SQUARE)

- Designed for Olympic style / recurve bows
- Apply all of sights

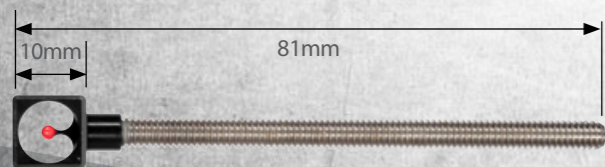

Black

SGP02 » SIGHT PIN (ROUND)

- Designed for Olympic style / recurve bows
- Apply all of sights

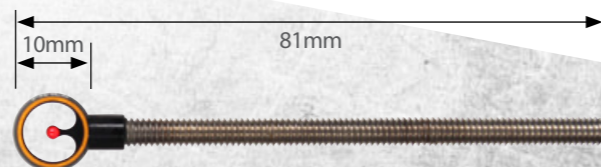

Black Gold

SIGHT DAMPERS

Extra special designed weight and damper are included



FVW501

FVW502

PHOENIX LINAFFECT WIND / 5000™

- STP15CL » PHEONIX 15000-B STABLIZER LONG(COMPOUND)
- STP15RL » PHEONIX 15000-A STABLIZER LONG + DC1500 DAMPER (RECURVE)
- STP15S » PHEONIX 15000-A STABLIZER SIDE (COMPOUND, RECURVE)
- STP15RX » PHEONIX 15000-A STABLIZER EXTENDER (RECURVE)

DIAMETER » 15.5mm
LENGTH » Long : 26", 28", 30" / Side : 8", 10", 11", 12", 13", 15" / Extender : 4", 5"
Type » A(Recurve type), B(Compound type)

* Suitable weight(All weight can be used for other stabilizers, but we recommend you to us the above in advance)

A TYPE RECURVE

Carbon Shaft + Aluminum frame structure make strong attachment of cap part.



B TYPE COMPOUND

Inner weight Extender is included(long)



Double structures of damper only move toward shooting way and there is no slop and slag. Efficient reducing vibration!



3 kid of weights are available and easy to assemble what you need along with headless bolts. **Weight** : 26g/52g/104g

CD1500 » PX1500 DAMPER



PX1500 WEIGHT



NEW



PHOENIX 15000-A STABLIZER LONG(RECURVE)

PHOENIX 15000-B STABLIZER LONG(COMPOUND)

CEX1900 STABILIZER SYSTEM

- STC19L » CEX1900 LONG STABILIZER
- STC19S » CEX1900 SIDE STABILIZER
- STC19E » CEX1900 EXTENDER

- 7 colors available
- Special metallic coating with vivid color
- Chrome coated cap
- Thickened extender
- Absorbing noise system
- Stabilizer screw top
- FSP system : Four Strong Pillar system
- One color extender

DIAMETER » 19mm
EXTENDER DIAMETER » 21mm
LENGTH » Long : 26", 28", 30" / Side : 10", 11", 12" / Extender : 4", 5", 6"
WEIGHT » 130g(30"), 86g(12")

* Suitable weight(All weight can be used for other stabilizers, but we recommend you to us the above in advance)

VBM01 » MAN V-BAR

Upgraded connecting bolt
ANGLE » 40° / 45° **MATERIAL** » Aluminum
COLOR » BLACK



VD200 » VD200 DAMPER



VWT 200 » VWT 200 WEIGHT



UP GRADE



VBM01 » MAN V-BAR

Upgraded connecting bolt
 ANGLE » 40° / 45° MATERIAL » Aluminum
 COLOR » BLACK



VBT04 » TR V-BAR

Easy to adjust, but strong holding for recurve bow
 MATERIAL » Aluminum



NEW

**UD1500 »
 PX1500 UPSTABILIZER**



**TNV 2300 »
 TNV 2300 UPSTABILIZER**
 Weight : 80g



**DC1500 »
 DC1500 DAMPER**

NEW



**CD1500 »
 PX1500 DAMPER**

NEW



1S45S16S 1S45S16L

*Applicable for all dampers

1/4-20



5/16-24

1/4-20



5/16-24



Black Silver Red Blue Pink

SM540 » SM540 CUSHION PLUNGER

Compact size to make easy setting



Thread : 5/16" - 24
 Adjustable Length : min 19.5mm, max 26.5mm

AL-COLOR WEIGHT

Diameter : 23mm, 20mm
 Material : Aluminum+Stainless

COLOR



WTAL1H
 Diameter : 23mm
 Weight : 44.3g



WTAL1F
 Diameter : 23mm
 Weight : 25g



WTAL2H
 Diameter : 20mm
 Weight : 31.5 g



WTAL2F
 Diameter : 20mm
 Weight : 18.2g

PX1500 WEIGHT

Diameter : 29mm
 Weight : 26g/52g/104g

WT15004

NEW



WT15002

WT15001

BRS001 » BUTTERFLY REST

Ambidextrous Design



Black Silver Red

Blue Pink Yellow

ACCESSORIES

ACCESSORIES

- Ergonomic design
- Adjustable ledge
- Replaceable face and backing
- Optional finger spacer available



BFT01A » BRASS SAKER 1

SIZE » L / M / S (RH / LH)
WEIGHT » L 162g, M 152g, S 144g
LEATHER » Cordovan



BFT02A » BRASS SAKER 2

SIZE » L / M / S (RH / LH)
WEIGHT » L 150g, M 140g, S 136g
LEATHER » Cordovan



FINGER SPACER

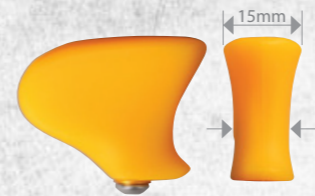

FS004D

Material : Rubber
Size : 39.8 x 29.3 x 16.2mm
Weight : 14g

COLOR



FS006

Material : Plastic
Size : 40 x 29 x 10mm
Weight : 10g



FS001

Material : Plastic
Size : 36 x 28.3 x 12.3mm
Weight : 8g

SFT01A » SAKER 1

SIZE » XL / L / M / S / XS / XXS (RH / LH)
LEATHER » Cordovan



COLOR



SFT02A » SAKER 2

SIZE » XL / L / M / S / XS / XXS (RH / LH)
LEATHER » Cordovan



COLOR



SFT03A » SAKER 3

SIZE » L / M / S (RH / LH)
LEATHER » Cordovan



COLOR



AC05CT » CARBON T-GAUGE BOW SQUARE

Material : Carbon

EP001 » SAKER 1 FINGER TAB FRAME EP

EP001 only fits Saker 1 finger tab
It offers top shooters another value for their hooking direction, comfortable and balanced.
This component enhances the saker finger tab's Ergonomic design



Size » saker1 XL , L = EP (L size)
saker1 M , S = EP (M size)
saker1 XS , XXS = EP (S size)



ST001S » AUTOMATIC (SHORT)

ST001L » AUTOMATIC (LONG)

BOW STAND

Height : 44cm [ST001S], 65cm [ST001L]
Weight : 573g [ST001S], 680g [ST001L]
Material : Aluminum



AC23PU » FIVICS ARROW PULL

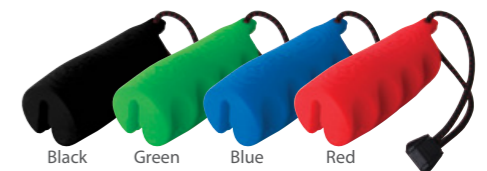

WA RULES Book3, Chapter 11, Article 11.18

The Technical Committee concluded that if the bar extends to the wrist but not beyond (extends at or before the contact point between the hand and the wrist), then the extension is legal.

World Archery C&R Committee, 22 September 2014

ACCESSORIES

ACCESSORIES

FIVICS
GEAR

Luxury

Secret masterpieces
World famous craftsman designed and made
research, production, planning and design.

BCHD01 » AEGIS HARD CASE DOUBLE



- High quality hardcase
- This model can hold up to two recurve bows and their accessories

Size : **33" X 15" X 10"**
Material : **ABS+PC**
Pocket : **1pcs**

**Recommended maximum weight : 23kg*



Pink

Blue

Red

Black

Silver

White

**ECRC01
HARDCASE RAIN COVER**



**ECB01
HARDCASE BELT**



Rain cover / Case belt included



ACCESSORIES



QV01UNTB » UNICO QUIVER LARGE
QV01UNTS » UNICO QUIVER SMALL

Artificial leather provide you with elegance.

Extra "L" size belts are on sales

SIZE » Large / Small
 WEIGHT » L-502g / S- 418g
 TYPE » RH / LH



QV01UNB » UNICO BACK

Artificial leather provide you with elegance.

Extra "L" size belts are on sales

TYPE » RH / LH RH / LH



QV02AT » ACCENDO TOURNAMENT

Light weight (630g)
 Large pocket for accessories

TYPE » RH / LH



QV02AB » ACCENDO BACK

Light weight (260g)
 Large pocket for accessories

TYPE » RH / LH



HPTKN » NATIONAL HAND POCKET

AVAILABLE FOR ANY COUNTRIES



GEAR

GEAR

CG02BD » BAND

Band system
Moving free

SIZE » L, M, S
TYPE » RH / LH



AM001 » ORGANIC WEB

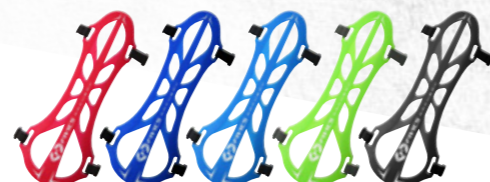

Red Blue Cyan Lime Black

CLOTHES

Size: XS / S / M / L / XL / XXL

AC29JW



AC29JY



CAPS



AC17CA



NAVY White **AC14CA**

AC17SO »

FIVICS LOGO SOCKS(3PAIRS=1SET)



AC20LP » Limb Protector

The device to protect the tip part and your feet when setting up bows.

Size : 56X97 mm
Material : Rubber



AC26CS »

COOL ARM SLEEVE



AC25UMBL » UMBRELLA

length : 1m
opened size : 1m 60cm



AC04CL »
CLOCK



GEAR

GEAR



3000 ARROW CHALLENGE

FIVICS PERFECT TARGET FACE

WATER PROOF

OUTDOOR TARGET FACE

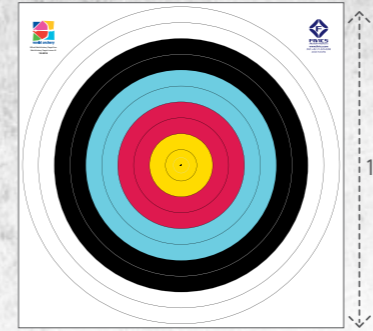

PT 001 OUTDOOR 122cm Target Face
Range: 90m / 70m / 60m
Mark dimension: 122cm X 122cm
Total dimension: 125cm X 125cm (width/length)



PT 005 OUTDOOR 40cm-5ring Target Face
Range: 30m / 20m
Mark dimension: 40cm X 40cm
Total dimension: 43cm X 43cm (width/length)



PT 007A OUTDOOR 48cm-6ring Target Face
Range: 50m
Mark dimension: 48cm X 48cm
Total dimension: 51cm X 51cm (width/length)

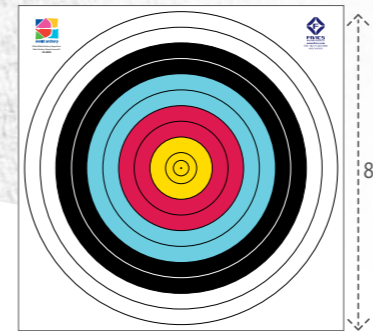

PT 002 OUTDOOR 80cm Target Face
Range: 50m / 30m
Mark dimension: 80cm X 80cm
Total dimension: 83cm X 83cm (width/length)



PT 006 OUTDOOR Triangular Target face(5Line)
Range: 30m / 20m
Mark dimension: (40cm-Center X 3Target)
Total dimension: 85cm X 85cm (width/length)

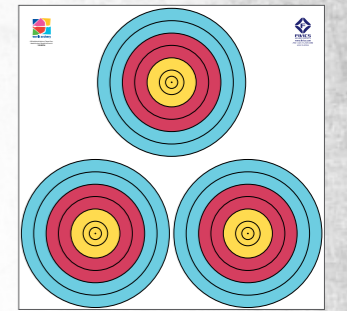

PT 007A3 OUTDOOR Triangular Target face(6Line)
Range: 50m
Mark dimension: (48cm-Center X 3Target)
Total dimension: 99cm X 98.5cm (width/length)

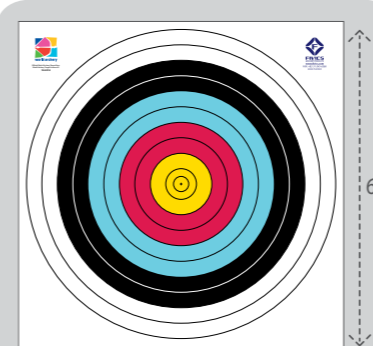

PT 003 OUTDOOR 60cm Target Face
Range: 25m
Mark dimension: 60cm X 60cm
Total dimension: 63cm X 63cm (width/length)

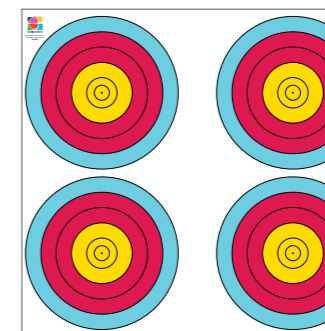

PT 007 OUTDOOR Target face(5Line)
Range: 30m / 20m
Mark dimension: (40cm-Center X 4Target)
Total dimension: 93cm X 85cm (width/length)

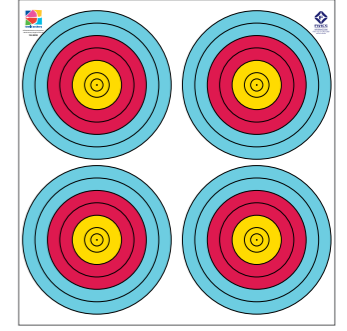

PT 007A4 OUTDOOR Triangular Target face(6Line)
Range: 50m
Mark dimension: (48cm-Center X 4Target)
Total dimension: 102cm X 105cm (width/length)

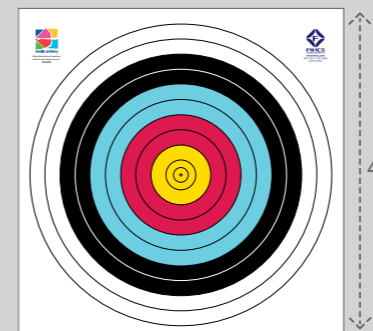

PT 004 OUTDOOR 40cm Target Face
Range: 18m
Mark dimension: 40cm X 40cm
Total dimension: 43cm X 43cm (width/length)

OUT/INDOOR TARGET FACE



ASIA ONLY ONE WA TARGET FACE LICENSED MANUFACTURER



ARROW & TARGET

ARROW & TARGET

INDOOR TARGET FACE

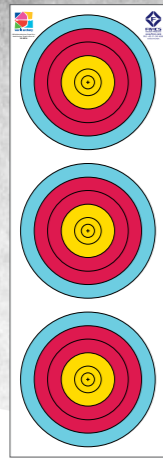

PT 008 INDOOR 20cm Target Face(18m)
Range: 18m
Mark dimension : 20cm X 3 Target
Total dimension : 23cm X 67cm (width/length)

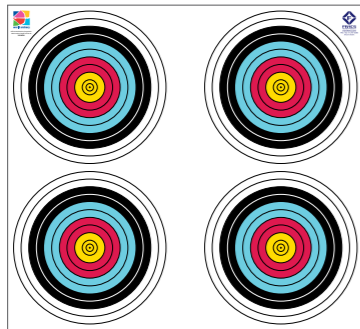

PT 009 INDOOR Single Target Face
Range: 18m
Mark dimension : 40cm X 4 Target
Total dimension : 93cm X 85cm (width/length)

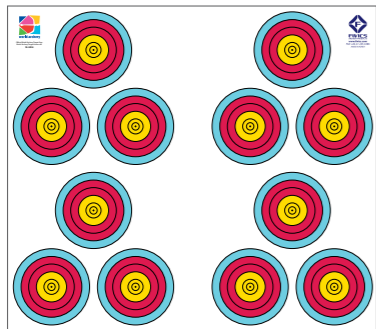

PT 011 INDOOR 20cm Triangular Triple Target Face
Range: 18m
Mark dimension : 20cm X 3 X 12 Target
Total dimension : 97cm X 85cm (width/length)

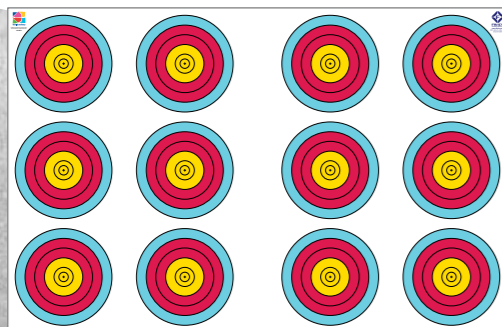

PT 010 INDOOR 12cm Target Face(18m)
Range: 18m
Mark dimension : 20cm X 12 Target
Total dimension : 103cm X 67cm (width/length)

TRAINING TARGET FACE



PT 012 TRAINING 80cm-CenterSpot Target Face(8Line)
Range: 50m/30m/20m
Mark dimension : 24cmX24cm
Total dimension : 32cmX32cm(width/length)



PT 013 TRAINING 122cm-CenterSpot Target Face(7Line)
Range: 90m/70m/60m
Mark dimension : 48.8cmX48.8cm
Total dimension : 61cmX61cm(width/length)

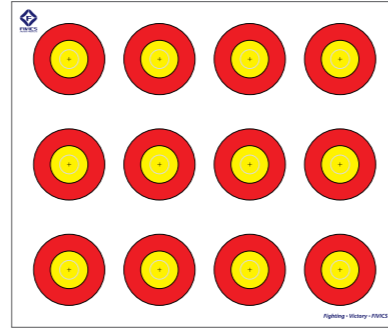

PT 020 TRAINING Target Face
Mark dimension : 52mmX52mm
Total dimension : 282mmX238mm(width/length)

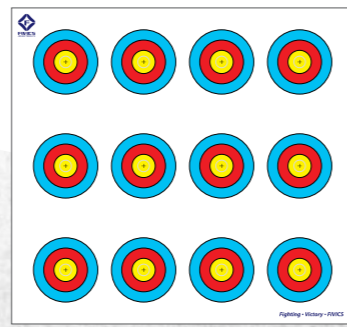

PT 021 TRAINING Target Face
Mark dimension : 48mmX48mm
Total dimension : 250mmX231mm(width/length)

FIELD TARGET FACE



PT 014 FIELD 80cm Target Face
Mark dimension : 80cmX80cm Target
Total dimension : 83cmX83cm(width/length)



PT 015 FIELD 60cm Target Face
Mark dimension : 60cmX60cm Target
Total dimension : 63cmX63cm(width/length)



PT 016 FIELD 40cm Target Face
Mark dimension : 40cmX40cm
Total dimension : 93cmX85cm(width/length)

ACADEMIC TARGET FACE



PT 017 OUTDOOR Target Face
Range: 70m
Mark dimension : 97.2cmX97.2cm
Total dimension : 103cmX103cm(width/length)

PAG001 » PERFECT SCORE SHEET



Name : Perfect score sheet
Total dimension : A4(21 X 29.7)
Applicable under any weather condition
Ink not smudged

* Blank page only
- You should print the score information or chart on the paper when you receive it.

PAG002 » TARGET SCORE BOOK



Waterproof



ASIA FIRST WA TARGET FACE LICENSED MANUFACTURER

ARROW & TARGET

ARROW & TARGET