



2013 PRODUCT GUIDE

www.fivics.com





The FIVICS quest for perfection is on-going.

FIVICS' pursuit of excellence is fueled by creativity, trial and error, and innovation coupled with a passion to bring you, the shooter the best products available.

FIVICS President
Baek, Jong Dae

A handwritten signature in white ink, appearing to read 'Baek, Jong Dae', is positioned to the right of the text identifying the president.



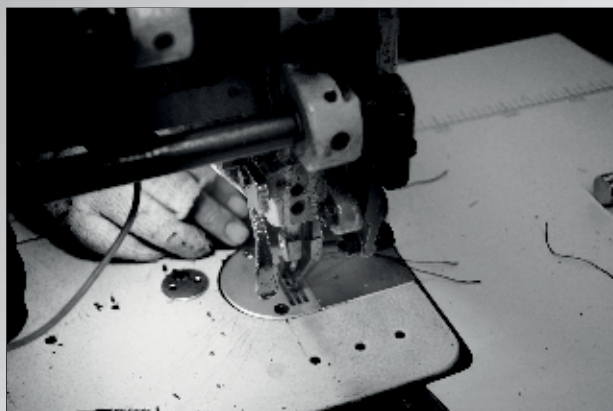

Company instruction

Our company is specialized in making archery products and sewing products such as hard cases, soft cases, clothes, travel bags, sporting goods etc.

Our company has 11 years' experience in production and "Research and Development" and has been stressing on innovation, development and quality control.

Our products are widely sold all over the world and have gained several patents of the state.

Cooperation with FIVICS makes for no hesitation and leaves worries behind!

We welcome all clients at home and abroad to visit and talk to us for mutual development.

HIGH FIVE VICTORY

FIVICS is the combination of the words
" **high five - victory**"

FIVICS would like to be with you at your moment
of victory.

We produce our products in the same manner
as that moment of "**ten ten ten**" after shooting.

THE FIGHTING SPIRIT AND AMBITION OF
FIVICS 4 PALM symbolizes the Fivics staff's
dedication to work and their grand ambition.
With this, "FIVICS" brand was born. Now "FIVICS"
Products have not only sold in domestic markets
but also exported to Europe, America, Australia
and southeast Asia, etc.

FIVICS is also the first company to achieve
"FITA - ASIA FIRST TARGET FACE LICENSE"

FIVICS looks forward to cooperating with friends
all around to gain mutual benefit and to
create a brilliant future together.





AT FIVICS, It is our mission to develop cutting edge innovations to help our customers reach their maximum potential.

Technology, creativity and experience all come together to bring you, the customer, the best quality archery equipment available.

Top shooter's Choice
FIVICS!!

New

SRV RISER

- STABILITY
- ACCURACY
- CONSISTENCY
- STYLISH DESIGN

FIVICS SRV RISER

*High performance recurve SRV riser
Tuning and harmony are dramatically advanced*

A CLEAN-FEELING SHOT
SUPERIOR ACCURACY

*Speed, Power, Balance, Precision, Elegance
all working with you, the archer,
in perfect harmony*



TRIPLE DAMPING SYSTEM



COLOR



SRV Riser SPECIFICATIONS

LENGTHS	25"
MATERIAL	Aluminum(6061), Rubber
WEIGHT	1,220g
TYPE	RH / LH
COLOR	BLACK, BLUE, RED, YELLOW, GREEN, PINK, WHITE



SRV *RISER*



[HM-SRV]



FIVICS

AL 7075

FX1 RISER

UPgrade

- SOLIDITY
- STABILITY
- ACCURACY

FIVICS FX1 RISER

100% CNC

High performance recurve FX1 riser
Tuning and harmony are dramatically advanced

A CLEAN-FEELING SHOT
SUPERIOR ACCURACY

Speed, power, balance, precision, elegance
all working with you, the archer,
in perfect harmony



FX1
RISER



● Pressure Point Direction

Normally, other high grip's pressure points become off-center, we had cut a useless part of the riser. The FIVICS high grip riser moves the pressure point to the center. Moreover, it helps the bow arm's shoulder, be comfortable when setting up



Normal High Grip

FIVICS High Grip

FIVICS Grip



High Grip

Middle Grip

High Grip

Middle Grip

TRIPLE DAMPING SYSTEM



[HM-FH1]

[HM-FX1]

COLOR



Fx1 Riser SPECIFICATIONS

LENGTHS	25"
MATERIAL	Aluminum(7075), Rubber
WEIGHT	1,290g
TYPE	RH / LH
COLOR	BLACK, BLUE, RED, YELLOW, GREEN, PINK, WHITE

AL 7075



- FOCUS ON STABILITY AND ACCURACY
- REDUCED YAWING TIME
- EXCELLENT WEIGHT BALANCE

FIVICS PXQ RISER

100% CNC

*High performance recurve PXQ riser
Tuning and harmony are dramatically advanced*

A CLEAN-FEELING SHOT
SUPERIOR ACCURACY

*Speed, power, balance, precision and elegance
all working with you, the archer, in perfect harmony*

The FIVICS PXQ riser



TRIPLE DAMPING SYSTEM





[HM-PXQ]

COLOR



PXQ Riser SPECIFICATIONS

LENGTHS	25"
MATERIAL	Aluminum(6061), Rubber
WEIGHT	1,330g
TYPE	RH / LH
COLOR	BLACK, BLUE, RED, YELLOW, GREEN, PINK, WHITE



[LM-FX1]

MERIDIAN FX1

MERIDIAN-FX1 *UPgrade*

LIMBS

Trying to reach the top of our game, the summit, the peak
 To do this, we search for the perfect balance between
 our potential and our equipment
 Now FIVICS has the key to the top of your climb. The Meridian FX1

CONSISTENT ENERGY

STABILITY

ACCURACY

By combining space age materials with an innovative recurve profile,
 the Meridian FX1 limbs offer maximum energy transfer to the arrow.
 Speed, stability and precise delivery all work in harmony to produce
 a shooting experience unlike any before.

SPECIFICATION

Using a premium wood core with high quality carbon to reduce vibration makes your shot fast and stable.

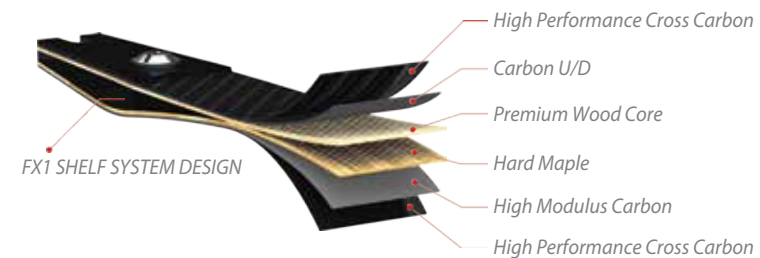

MERIDIAN FX1 & MERIDIAN RX1

Available Lengths : 66" 68" & 70"

Available weights : 2# increments





[PG-FX1]

MERIDIAN RX1

MERIDIAN-RX1

LIMBS

*The quest? Simple, to design a limb that exceeds all others.
The method? Find out what archers want and go beyond.
The vision? Create a limb that eclipses all expectations.*

Premium Shooting Feel

*FIVICS engineers have combined the latest in space age materials with cutting edge design innovations to bring you a limb with no equal.
Introducing THE MERIDIAN FX1 & MERIDIAN RX1*

CONSISTENCY, STABILITY, ACCURACY ...MERIDIAN FX1 & MERIDIAN RX1

FORCE-DRAW CURVE

FIVICS "MERIDIAN FX1 / MERIDIAN RX1 Limbs medium length on 25" riser 40.3 lbs @ 28"/30"/32"

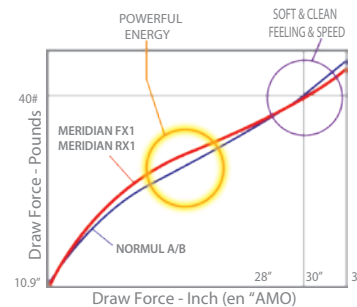

Draw Weight : 40.3 lbs @ 28"/30"/32"
Limb Length : medium (68" Bow Length on 25" Riser)
Brace Height : 7-3/4"-8-3/4" (depending on riser)
Physical Weight : 365 Gramm oz (pair)

SPECIFICATION

Using a foam core with high quality carbon to reduce the vibration, makes your shot fast and stable.

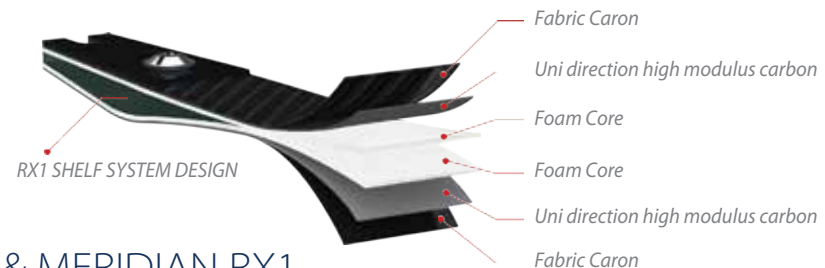

1 SECOND

Absorption of vibration





[LM-PS]

PEGASUS

PEGASUS

LIMBS

Multi-core System!!

1. Complete strong power, speed and stability.
2. The premium wood core and the high quality of carbon's extreme elasticity help limbs to recover from the vibration.
3. Push the tip part from limbs with a powerful feeling.

Available lengths : 66" 68" 70"
 Available weights : 26#~48#
 (In 2# increments)

Premium Shooting Feeling

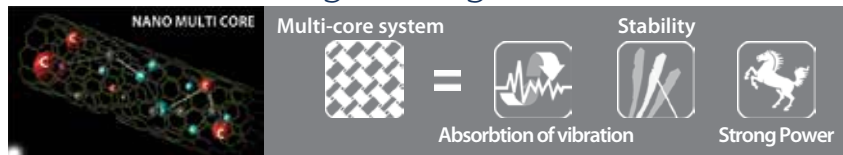

SUPERIOR STABILITY

What Multi-core system is!

Using premium wood core with high quality carbon to reduce the vibration, makes your shot fast and stable.

SPECIFICATION

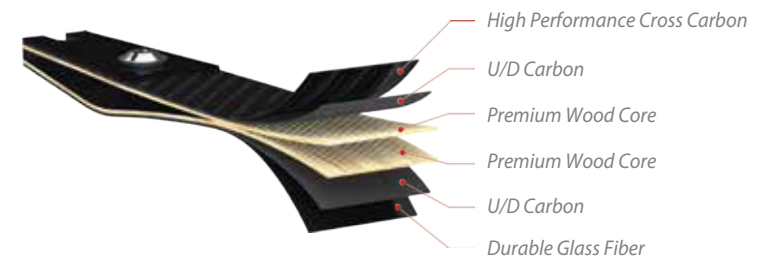

FV-100 ^{UPgrade}

CARBON , ALUMINUM SIGHT

Exclusive style, Excellent Accuracy
Simple system design
Quiet with reduced vibration



Size

▪ Extention 9 inches

Anodized COLOR



FV-200 ^{UPgrade}

CARBON , ALUMINUM SIGHT

Best accuracy
Strong, solid and detailed design



Size

▪ Extention 9 inches

Anodized COLOR



SIGHT CASE

A Style

Well-arranged pocket system,
durable case, fancy design

Size : 10.6"X7"X2.2"



[EA-CS]



COLOR



A+ Style ^{New}

durable bigger case.

Size : 12.3"X8"X2.5"



[EA-CL]

COLOR



B Style

Compact designed sight case

[S-CS]



C Style

Handy sight protection case



[S-CSC]

COLOR



SM740

CUSHION PLUNGER

Designed to reduce friction with BTX coating. Designed neatly with internal innovations for advanced micro-adjustments. Smooth control system for the best aerodynamics to reduce effects from wind.

Thread : 5/16" - 24

Adjustable Length : min 19.5mm, max 26.5mm

Anodized COLOR



[SM-C]

SM540 ^{New}

CUSHION PLUNGER

Steady pressure point. Designed to reduce friction with BTX coating. Simple control system.

Thread : 5/16" - 24

Adjustable Length : max 24.5mm

Anodized COLOR



[SM-C2]

FIVICS PULL - FOR ALL ARCHERS

Ergonomic detail design for both hands and shaft for safety. Fancy colors, a soft feel and highly effective. Easy to use.

Anodized COLOR



[AR-P1]



TC ^{UPgrade}

REST

Height adjustable high-end stainless steel rest. Durable construction for precise and secure positioning.



[MR-T]

MR ^{UPgrade}

REST

Solid design for zero tolerance of error in position and angle. Stainless steel ensured durability while reducing friction.



[MR-A]

PR

REST

Durable, inexpensive Beginner rest



[PR-F]



**SHOOTING WITH
FIVICS STABILIZER
IN 2012
LONDON OLYMPIC**





PHOENIX

COMPOUND & RECURVE STABILIZER

Weight and vibration problems? Solved!

Tournament stabilizer, 'PHOENIX' incorporates an advanced and highly elastic material. Normally, top compound shooters use many weights on the stabilizer, but a normal stabilizer cannot control the weight and vibration together. However, the PHOENIX tournament stabilizer has a very strong spine, which equals no noise and vibration. Now it's ok to use many weights, because more weight equals better vibration reduction like never before. Moreover, the PHOENIX tournament stabilizer has a light but durable spine, and is ideal for all men and women.

Painted COLOR	Long Stabilizer	24", 27", 30", 34"
	Side Stabilizer	10", 11", 12"
	Extender	4", 5", 6"

Diameter : 22mm



WEIGHT

Thread Size : 1/4-20 UNC
Size : 38mm(5T/3T) , 24mm(5T/3T)

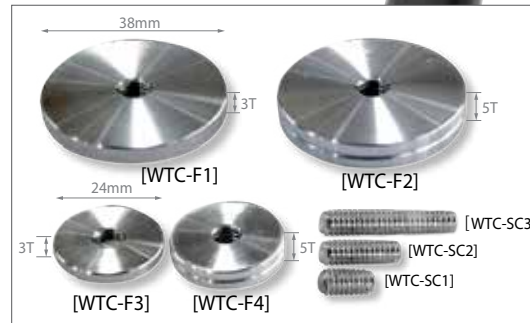

Strong Spine

- Highly elastic material
- Strong spine
- No noise, No vibration
- It's ok with lots of weights
- Great stability
- Light shaft



CEX7 STABILIZER

High-end stabilizer from FIVICS offers the shooter stability and balance,
Stabilizer cap designed for aerodynamics.
CEX7 carbon balance system.
Best durability and weight balance.



Diameter : 18.7mm

Painted
COLOR

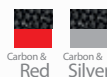

Long Stabilizer	26", 28", 29", 30", 34"
Side Stabilizer	10", 11", 12"
Extender	4", 5", 6"

WEIGHT



CEX7 stabilizer is threaded at both the shaft end, and cap. It can never come off.



VZ 2000 DAMPER

Fit any stabilizers.
Eliminates noise at inside bolt.
Best damper absorption system



VZ 1500 DAMPER

Designed to fit any stabilizer.
Best V-ZERO damping system.
No noise with rubber bolt inside.



V-ZERO DAMPER





THE INNOVATION OF SHOOTING FEELING

CEX5 STABILIZER

The aim of the CEX5 stabilizer is total balance and harmony with the arrow. It's the best stabilizer for speed and vibration reduction, the CEX5 has passed careful inspection successfully, it makes archers confident, and it is different from other stabilizer.

To eliminate even the smallest vibration
Support the highest speed and stability
Oscillation control available for both recurve and compound bow

- Long Stabilizer** 26", 28", 29", 30", 34"
- Side Stabilizer** 10", 11", 12"
- Extender** 4", 5", 6"

Special Strong Spine Material

Painted COLOR



- 2 Tone Carbon & Red / Blue / Silver / Black
- 1 Tone Red / Blue / White / Orange

Diameter : 18.5mm

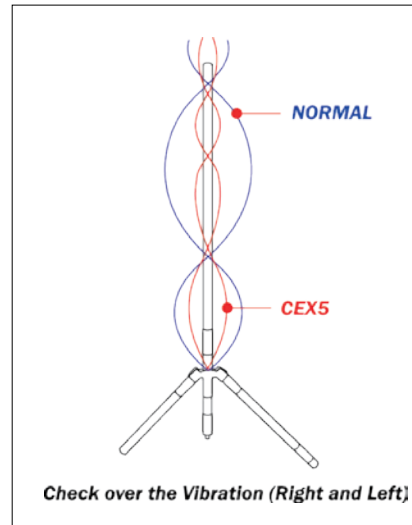

Whole Vibration of it's Body



WEIGHT



[WT5-F]

Diameter : 23mm
Weight : 36g

[WT5-H]

Diameter : 23mm
Weight : 50g

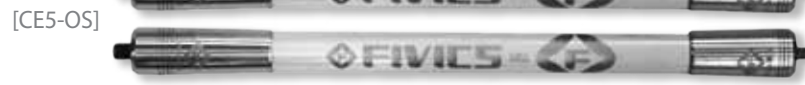

MAX PRO

MAX PRO STABILIZER *New*

High quality carbon stabilizer for intermediate shooters differentiated stability and concentration

Long Stabilizer	26", 28", 30"
Side Stabilizer	9", 10", 12"
Extender	3", 4", 5"

Painted COLOR



Carbon & Red / Carbon & Blue / Carbon & Black / Carbon & Orange

Diameter: 18.5mm



CEX²+

CEX2+ STABILIZER

CEX2+ stabilizer weave of pure carbon layer gives Hawk's Back unequalled strength, even on light weight pure carbon shafts. The cross-woven method of construction is proven to deliver exceptional strength without added weight.

The front side of the long stabilizer cap is made out of stainless steel, so when shooting, it offers better shooting balance.

Long Stabilizer	24", 26", 27", 28", 29", 30"
Side Stabilizer	9", 10", 11", 12"
Extender	3", 4", 5", 6"

Diameter: 18.2mm



[FOR ALL STABILIZERS]

CONNECTING WEIGHT *New*



[WT-C1]
Diameter : 23mm
Weight : 38g



[WT-C2]
Diameter : 23mm
Weight : 56g



[WT-C3]
Diameter : 23mm
Weight : 36g

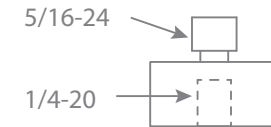
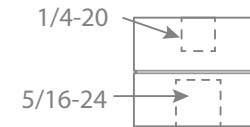
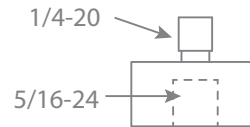

[stabilizer + damper + weight head]

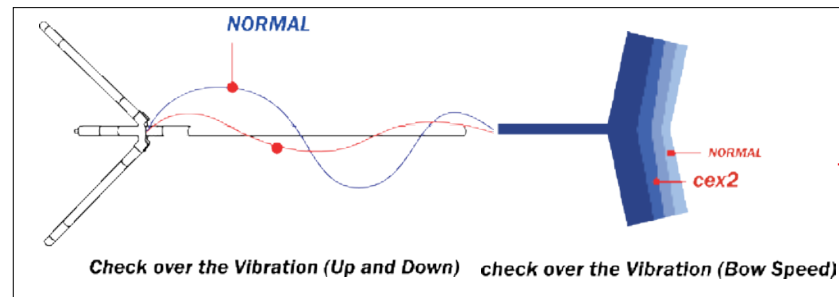

WEIGHT



[WT-F]
Diameter : 20mm
Weight : 26g



[WT-S]
Diameter : 20mm
Weight : 22g



[WT-H]
Diameter : 20mm
Weight : 40g



MAN V-BAR



[VB-M]

Angle : 40° / 45°



RF V-BAR



[VB-R]



*Light and durable.
A perfect combination for balanced shooting*

Angle : 40° / 45°
Weight : 75g (Connecting bolt included)

COM ADJUSTABLE OFFSET SIDE MOUNT

*Fully adjustable offset side mount,
Solid machined aluminum
Adjustable angle measurement system*



[CO-AC]

Color: Black
Material: Aluminum

TR V-BAR

*Adjustable 360
Horizontal and vertical adjustable system
Easy to use*



[VB-T]

Color: Dark Grey
Material: Aluminum

DP
V-BAR *New*



[VB-D]

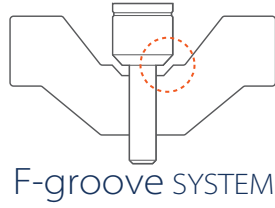

Horizontal balanced control system

Angle : 40° / 45°



TRS
V-BAR *New*



[VB-TR]



Energy forwarding system

Angle : 40° / 45°

TRI
V-BAR *New*

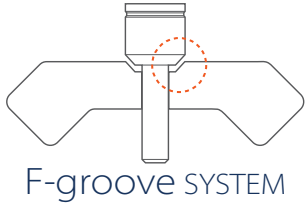

Vertical balanced control system

Angle : 40° / 45°

[VB-V]



COM CONNECTING BOLT

A much better connecting bolt that gets long stabilizers 10 degrees lower, absorbs vibration
Easy and quick detach system

◆ 10 Degrees Lower



Color: Black
Material: Aluminum



UNI-BAR

[UNI]



TOP UPSTABILIZER TNS SET

Versatile vibration reduction system design and material
Available in a variety of colors



TNS N300 **TNS 1000** **TNS 500**

Anodized COLOR



SQ EXTENDER

V-zero damping system insert extender.
Rubber is inserted in the stainless steel rod



weight : 160g

Anodized COLOR



[SQ-E]

TNV 2200, 2300 *New*



[TNV-2200]

[TNV-2300]

TNV 1500, 1600 *New*



[TNV-1500]

[TNV-1600]

TNS 300

TNS 300SET : TNS 300 + V-Zero damper + weight head

Anodized COLOR
Black Silver



[TNS 300]

N-SHOCK DAMPER

N-Shock damper by BJD technology uses the slogan, "NO SHOCK", "NO VIBRATION", "NO NOISE" perfectly matched with all stabilizers from FIVICS.

Size : 39 x 20 x 20mm
Material : Aluminum, Rubber
Color : Black, Silver, Blue, Red

Weight : 24g



[NSD-A/B]

WEIGHT DAMPER *New*

Noise absorption between each weight.
Easy to screw down and up

Material : Rubber
Color : Black, Blue, Red



[WED-L]



[WED-S]

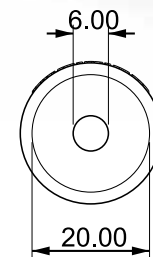
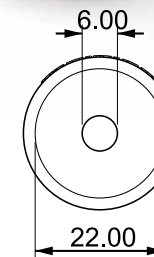

Top shooter's Choice

SAKER FINGER TAB



HIGH FIVE VICTORY

SAKER FINGER TAB SERIES

BRASS SAKER

Excellent stability with extra weight
Ergonomic design
brass plate
Adjustable ledge
Replaceable face and backing
Optional finger spacer available

BRASS SAKER 1 ^{New} FINGER TAB

Size : L / M / S (RH / LH)
Weight: L 162g, M 152g, S 144g
Leather : Cordovan

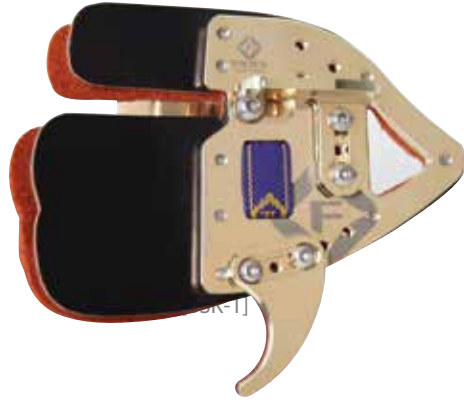

BRASS SAKER 2 ^{New} FINGER TAB

Size : L / M / S (RH / LH)
Weight: L 150g, M 140g, S 136g
Leather : Cordovan

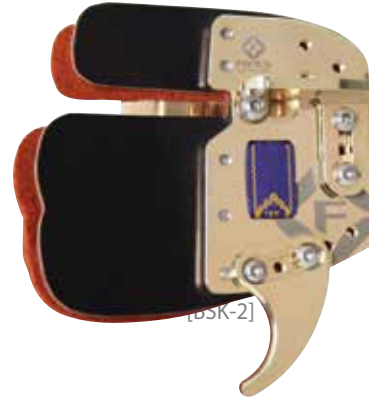

BRASS SAKER 3 ^{New} FINGER TAB

Size : L / M / S (RH / LH)
Weight: L 130g, M 128g, S 112g
Leather : Cordovan



SAKER

Ergonomic design
Anodized aluminum plate
Adjustable ledge
Replaceable face and backing
Optional finger spacer available

SAKER 1 ^{UPgrade} FINGER TAB

Size : XL / L / M / S / XS / XXS (RH / LH)
Leather : Cordovan

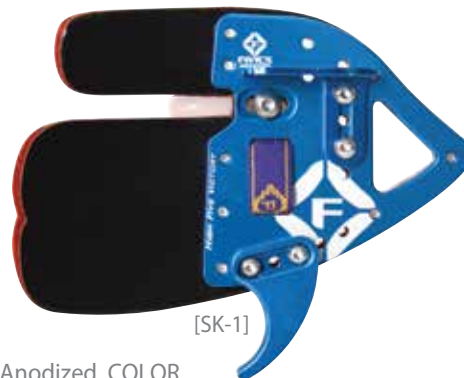

Anodized COLOR



SAKER 2 ^{UPgrade} FINGER TAB

Size : XL / L / M / S / XS / XXS (RH / LH)
Leather : Cordovan



Anodized COLOR



SAKER 3 ^{UPgrade} FINGER TAB

Size : L / M / S (RH / LH)
Leather : Cordovan



Anodized COLOR



SAKER 1 FINGER TAB FRAME EP

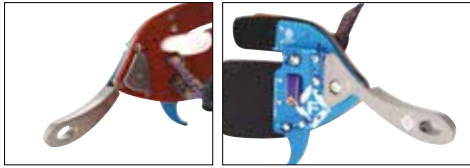

FB-EP only fit Saker 1 finger tab
It offers top shooters another value for their hooking direction, comfortable and balanced.
This component enhances the saker finger tab's Ergonomic design



Size : saker1 XL , L = EP (L size)
saker1 M , S = EP (M size)
saker1 XS , XXS = EP (S size)

CORDOVAN TAB

Functional with hand protected cordovan leather
Light and soft

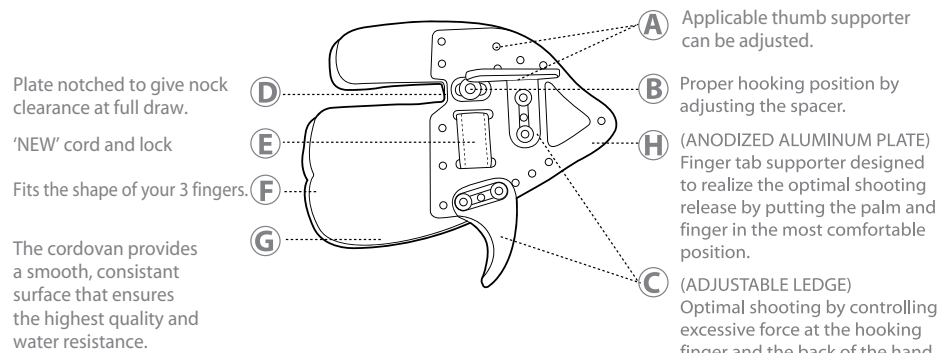

Ergonomic Finger Tab

Finger support patent®

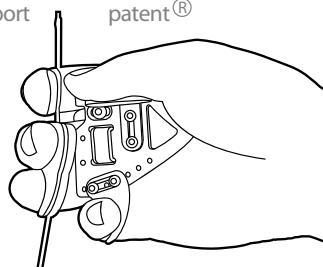

FINGER SPACER

Material : Plastic



[FS-A]

Material : Rubber



[FS-B]

Material : Aluminum



[FS-C]

Material : Rubber **New**



[FS-D]

Color : Darkbrown, Blue, Red, Yellow, Green



Material : Brass **New**



[FS-E]

THUNDER CC (DOUBLE) ^{UPgrade}

COMPOUND BOW CASE



[CPC-T]

Interchangeable wheel



Upgraded handle to carry
 Protect compound bows with a durable fabric and angled case
 Extra pockets for accessories
 Convenient to carry
 Easy transportation system with strong wheels
 Interchangeable wheels
 Room for two compound bows

Dimension : 15" x 45" x 12"

Fabric COLOR



Red



Arrow tube + Rain cover included

THUNDER CCS (SINGLE) ^{New}

COMPOUND BOW CASE



[CPC-TS]

Interchangeable wheel



Protect compound bows with Durable fabric and angled case
 Extra pockets for accessories
 Convenient to carry
 Easy transportation system with strong wheels
 Interchangeable wheels
 Room for one compound bow

Dimension : 15" X 45" X 6.5"

Fabric COLOR



Red



Arrow tube + Rain cover included

THUNDER RC (DOUBLE) ^{UPgrade}

RECURVE BOW CASE



[RCC-700]



Convenient to carry
 Easy transportation system with strong wheels
 Interchangeable wheels
 Room for two recurve bows

Dimension : 14" X 36.5" X 12"

Fabric COLOR



Arrow tube + Rain cover included

THUNDER RCS (SINGLE) ^{New}

RECURVE BOW CASE



[RCS-700]



Convenient to carry
 Easy transportation system with strong wheels
 Interchangeable wheels
 Room for one recurve bow

Dimension : 14" X 36.5" X 7"

Fabric COLOR



Arrow tube + Rain cover included

X-500 *New* TROLLEY BACKPACK

*Trolley bag
Well-arranged pockets
Room for one bow and accessories*

Dimension : 27"x13.5"x9"



[TB-1]

X-300 *New* TROLLEY BACKPACK

*Trolley bag
Compact design
Well-arranged pockets for travellers*

Dimension : 22"x13"x8"



[TB-2]

SMARTRON-B *New*

Stylish briefcase
Front pocket



[TB-3]

UNITON-G *New*

Handy small zip-pocket in front
1 large main zip
Casual sporty bag



Fabric COLOR
 Black
 Blue
 Red



[TB-5]



UNITON-Y *New*

Cross-body travel bag



[TB-4]



CO-STAR BACKPACK

Stylish hybrid backpack

Fabric COLOR



[BP-C4]



- Arrow tube
- Equipment case
- Riser & Limbs case included



TENTRON-J BACKPACK *New*

Durable Nylon material
Many front zippered pockets with mesh-lined Interior
interior padding
Built in laptop compartment

[BP-C4]



TENTRON-Q BACKPACK

Durable shoulder straps
Well-arranged pockets
Interior padding
Built in laptop compartment

Fabric COLOR



[BP-C3]





[HC-A]

AEGIS HARDCASE

High quality hardcase
This model can hold up to two recurve bows and their accessories
It's equipped with a locked key system

Size : 33" X 15" X 10"
Material : ABS
Pocket : 1 pcs

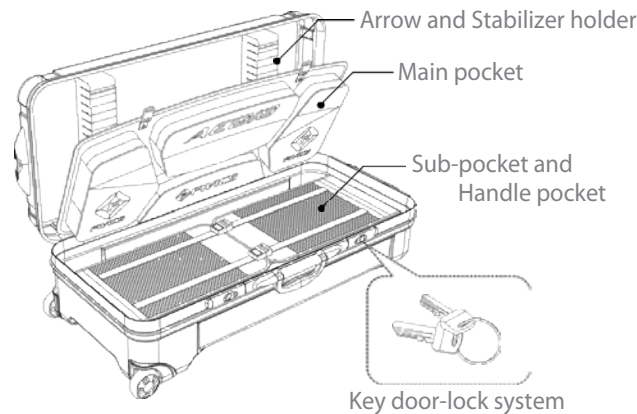
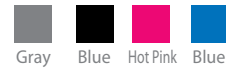

Rain cover / Case belt included

RAIN COVER



[HC-RC]



CASE BELT

[HC-BT]



[REINFORCED BACK PANEL & WHEELS]

V-STORM CC ^{UPgrade} COMPOUND BOW CASE

Simple and convenient design with the best quality.
The best elastic interior padding
Keeps the bow safe
Simple arrangement with
two outer pockets

Size : 38"
Pocket : 2pcs



V-STORM RC 500 ^{UPgrade} RECURVE BOW CASE

Size : 36"
Pocket : 2pcs



RISER FOAM CASE

Interior padding [RS-CS1]



LIMBS FOAM CASE

Interior padding [LM-CS]



RISER & LIMBS CASE

[LR-CS]



TENTRON-M BACKPACK

Special ergonomic design
Organizational pockets for today's latest technology
Reflex cloth used for safety, durable material and brightly colored



Size : 11.8" X 7.8" X 26.7"

Pocket : 1pcs

Fabric COLOR



- Arrow tube
- Equipment case
- Riser & Limbs case included



[BP-C1]

TENTRON-P BACKPACK

Compact design



Size : 11" X 7" X 26"

Arrow tube / Riser & Limbs case included



[BP-C2]

TOOL BOX SOFT CASE

Three plastic cases included for tools such as Nocks, points, rests, vanes, wrench sets etc.
One front zip pocket
Adjustable shoulder strap
Strap Padding included for shoulder safety
Easy to carry

Size : 8.5" X 6.5" X 7"



[TB-7]



EQUIPMENT CASE

Well-arranged and slim design fits all equipments inside (sight, short stabilizer, extender, v-bar, wrench set etc)

Size : 15.5" X 9"



[EC-09]



Fabric COLOR



ACCENDO TOURNAMENT ^{UPgrade} QUIVER

Light weight
Large pocket for accessories
Upgraded belt material
For T-gauge
Pen holder
Record carrier

Size : 14.9"(width) x 19.2 (height)
x 2.95 (thickness)
Belt size : 32" ~ 40" (M)
36" ~ 44" (L)
Weight : 630g

Fancy design
Light and durable

Fabric COLOR : RH / LH



[AC-Q]

XK ^{New} QUIVER

Colorful design
Artificial leather
Pen holder
Record carrier

Belt size : 32" ~ 40" (M)
36" ~ 44" (L)

Fabric COLOR :
RH / LH



[XK-Q]

XC ^{New} QUIVER

Colorful design
Artificial leather
Pen holder
Record carrier

Belt size : 32" ~ 40" (M)
36" ~ 44" (L)

Fabric COLOR :
RH / LH

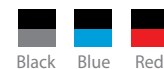

[XC-Q]

ACCENDO BACK ^{UPgrade} QUIVER

Fancy, but simple design

Size : 8.6"(width) x 18.1 (height)
x 2.95 (thickness)
Belt size : 32" ~ 40" (M)
36" ~ 44" (L)

Weight : 260g

Fabric COLOR : RH / LH



[AC-QM]

NURI QUIVER

Pockets for wrench set
Room for all accessories

Belt size : 32" ~ 40" (M)
36" ~ 44" (L)

COLOR : RH / LH



White



[AM-1]

MIRACLE 500 QUIVER

Double pocket system
High performance line

Belt size : 32"~44"

Fabric COLOR : RH / LH



Black Silver Blue Red Orange



[MC-05]

MIRACLE 300 QUIVER

Multiple fashionable colors

Belt size : 32"~44"

Fabric COLOR : RH / LH



Black Silver Blue Red Orange



[MC-03]

FREENIC PLUS QUIVER

Upgraded stylish design
Simple and durable

Belt size : 32"~44"

Fabric COLOR : RH / LH



Black Silver Blue Red Orange



[LS-Q3]

METEOR 500 QUIVER

Simple and light
3 tube design

UPgrade

Fabric COLOR : RH / LH



Silver Yellow Green Pink



[MT-Q5]

METEOR 300 QUIVER

Bright color
2 tube design

UPgrade

Fabric COLOR : RH / LH



Black Green Blue Red



[MT-Q3]

3LEVELS FOLDING

BOW CASE

Innovative design : Very easy to carry your Complete set of equipment.

Fabric COLOR



STABY

CASE

Case for full stabilizer set



Fabric COLOR



SHELTER PLUS_NATIONAL

CHEST GUARD

Highly comfortable and Safe ergonomic design

Weight : 94g



A2

CHEST GUARD

Elastici shoulder band Adjustable side fastener

Fabric COLOR

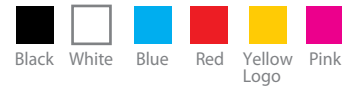

[AP-A2]



RAINBOW SHIELD

ARMGUARD

Black White Red Orange Pink Purple Yellow Green Skyblue Blue

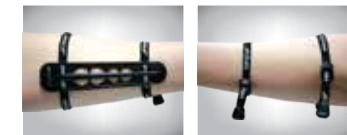

[SP-R]

USA **New**

FRA **New**

ITA **New**

JPN **New**

GBR **New**

GER **New**

ESP **New**



AVAILABLE FOR ANY COUNTRIES

TK2 *UPgrade*
HAND POCKET



TK3 *New*
HAND POCKET



NATIONAL *New*
HAND POCKET



AVAILABLE FOR
ANY COUNTRIES

USA

CHN

FRA

KOR



**HK EQUIPMENT
HOLDER**



**GABO
BOW STAND**

*Spring-loaded
Aluminum body makes setting simple,
Conveniently designed stand*

Height : 44cm
Material : Aluminum

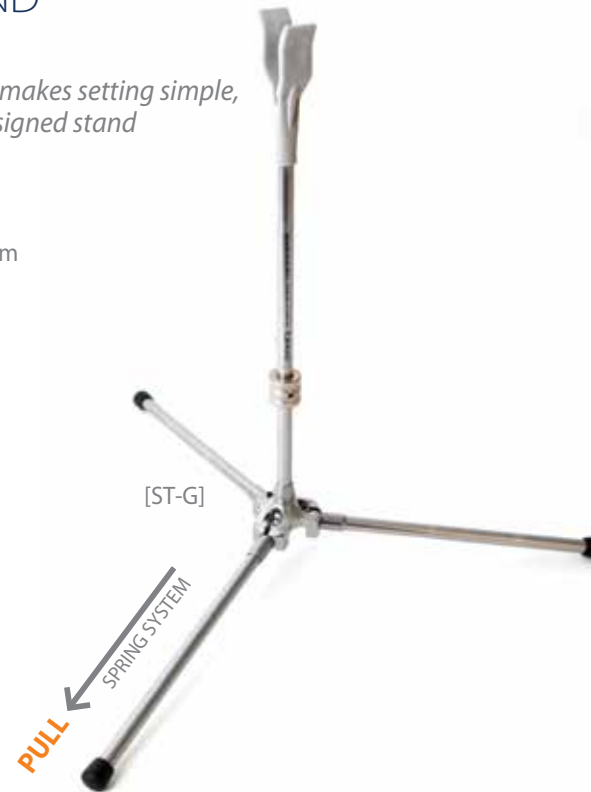

**AUTOMATIC
BOW STAND**

Height : 44cm [ST-A], 65cm [ST-B]
Weight : 573g [ST-A], 680g [ST-B]
Material : Aluminum



SLING *UPgrade*

It's soft but uses strong and highly durable material.



[SG-10]

FIVICS ARROW TUBE *New*



[AT-F1]



GRAIN SCALE

LCD digital screen display
15 grain accuracy
Weights- Grains, Grams,
Ounces and CWT
Extremely small 5"X3"X3/4"
Lightweight 6 oz



[GSE]

Model : 60200
Description : Electric scale
Inner pack : 3
Case pack : 12

HEX-I ALLEN WRENCH

Ergonomic simple design
Compact and portable
Colorful, durable and exquisite wrench

Material : Aluminum

Weight : 90g
Spec : 1.5 / 2.0 / 2.5 / 3.0 / 4.0 / 5.0

┌ Metric ┐ ┌ Inched ┐
Purple Red Blue Yellow



[HAW-2]

[HAW-1]

QUICK GRIP MARKER

Customize your grip!
Our material gives you a simple and fast solution that can be molded and cut easily for a sure fit to your unique hand. Hardens and is waterproof in 80 minutes.



Size : 4 inch, 8 inch



[GM-8]



[GM-4]

How to use :



CUT

MIX

APPLY

SANDING

FIVICS STRINGER *New*

Easy to use



[SG-12]



LIMB PROTECTOR

Limb set up supporter protects top of the foot
Comfort & easy to use double comfort and
Easy to use double sided



Size : 56X97 mm
Material : Enamel, Rubber



[LP-1]

T-GAUGE BOW SQUARE *New*

CARBON

*Pliable strong carbon
Easy hang up style*

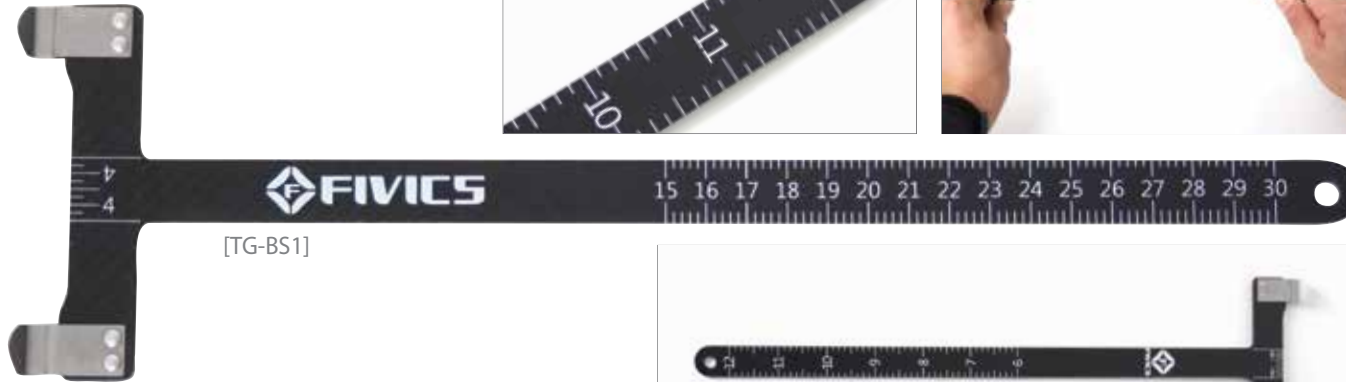

BALANCE KEEPER *New*

STANCE CONTROLLER

For archers' feet who walk and stand for a long time



[BK-SC]

EZ FLETCHER

EZ FLETCHER

MULTI-FUNCTION SYSTEM!!

*Better accuracy and convenience
Developed stability, certain control system
Perfect balance for every arrow
Holding system for the best set up
Easy to use, ergonomic design*

EZ FLETCHER by BJD Technology has
Shaft hold system, pincers control system
And strength adjustment system



Shaft hold system



FEATURE

MATERIAL : Aluminum
SIZE : 124 x 124 x 220
COLOR : Black





SOMA
TECHNICAL BRAND SOMA

SOMA means (Physical + spirit) = SOUL

TECHNICAL LINE

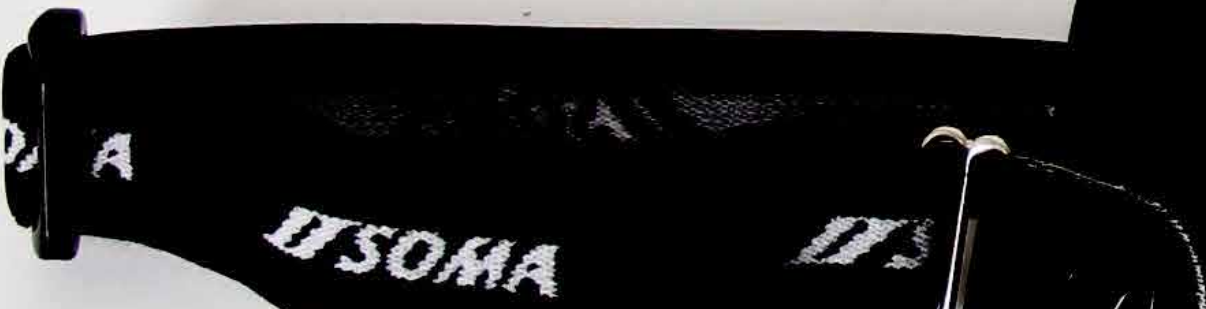

SCORPION SIGHT



High quality recurve target sight strong, light-weight aluminum construction

Size : 9.5" (inch) (RH / LH)

Anodized COLOR

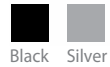

Black Silver

[SC-E]

FALCON SIGHT

Mid-level target sight with light aluminum construction
Quick detach bow mount
Available in black only

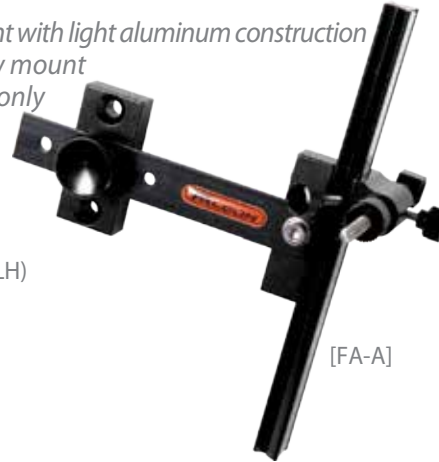

Size : 4" (inch) (RH / LH)

Anodized COLOR



Black

[FA-A]

BLACK SHARK SIGHT

High-impact polymer and nylon
Light weight and durable
Great introductory sight



Size : 4" (inch) (RH / LH)

Anodized COLOR



Black

[BS-A]

JM ^{UPgrade} FINGER TAB

Size : L(BL) / M(RD) / S(YLW)

Leather : COWHIDE - [JMT-1HD], [JMT-2HD]



[JM-A]

[JM-B]

COLOR



Blue Red Yellow

NEONINE FINGER TAB

Size : L / M / S (RH/LH)

Leather : Cowhide



[NA-A]

[NA-B]

COLOR



Blue Red Yellow

MAGIC FINGER TAB

Size : L / M / S (RH/LH)

Leather : Cowhide



[MG-A]

SPORTER FINGER TAB

Size : L / M / S (RH/LH)

Leather : Cowhide



[ST-A]

Size : 17mm ~ 25mm

CLOVER FINGER TAB

Size : L / M / S (RH/LH)

Leather : Cowhide



[CV-200]

HQ ARMGUARD



[HQ-P]

COLOR



SPIDERMAN ARMGUARD



[AG-SP]

COLOR



SUPERKING ARMGUARD

Size : S/M/L



[SP-K-3]



[SP-K-2]



[SP-K-1]

COMPOUND BOW STAND

Works on most bows
Easily slips into quiver or pocket
Light weight folding kickstand
Not spring-loaded
Available only in black

Weight : 94g
Material : Plastic



[CST]

AQ ^{New} T-GAUGE BOW SQUARE

Material : Aluminum

COLOR



[T-2]



LVT STABILIZER

Vibration reduction shock eater design
High quality carbon construction
Available color: silver / black

New

Diameter : 17mm

Long Stabilizer	26", 28", 30"
Side Stabilizer	10", 12"
Extender	3", 4"

Anodized COLOR



Black



LVT V-BAR

Anodized COLOR



Black Silver

[LVT-B]

Angle: 35° / 40°



[LVT-V5]

LVT DAMPER

New



[LVT-DZ]

LVT WEIGHT

New



[LVT-WZ]

S1400 *New*
BACKPACK

2 zip front pockets

[BP-C5]

Fabric COLOR



Riser & limbs case, arrow tube included



S1600 *New*
BACKPACK

Fabric COLOR



- Arrow tube
- Rain Cover
- Riser & Limbs case included



[S-1600]

S500 *New*
QUIVER

3 tube design



[S-Q5]

S300 *New*
QUIVER

2 tube design



[S-Q3]

V-STORM RC 300 *UPgrade*

Size : 35"
Pocket : 2pcs

[RCC-300]



S80 *New*
HAND POCKET



[TK-D]

SE-6 *New*
CHEST GUARD

Comfortable and light material



[AP-6]

SE-4
CHEST GUARD

Adjustable Velcro system



[AP-A4]

SE-1
CHEST GUARD

Adjustable buckles



[AP-A1]

SE-C
CHEST GUARD

Light and airy material



[SE-C]

BLAZE BEGINNER BOW

Handle	19", 20", 24"
Limb	54", 62", 64", 66", 68", 70"
Pound	10~24 / 14~36 / 16~38 / 12~34 / 14~36 / 18~38
Material	Hard maple, Rosewood, Walnut, fiber glass



[WB-HL]

SOMA STRINGER

Strong string with tough cowhide



[SG-11]

LEO CUSHION PLUNGER

Precision manufacturing for zero tolerance error.
High endurance BTX coating for the elimination of friction.



[LEO-C]

Anodized COLOR



AQUILA BOW STAND

Height : 48cm
Weight : 360g
Material : Rubber / Aluminum

3 Stable legs
Flexible Rubber



[JST]

SOMA ARROW TUBE

[JST-2]



ARM SUPPORTER

Arm Supporter helps to deliver Strength to back of the arm and to prevent using fingers when beginners Shoot.

Size : S / M / L

[AS-B]



SOMA RISER CASE New



[SRC-1]

SOMA LIMBS CASE New



[SLC-1]

STRETCH BAND

This stretch device is used by most Olympic archers for training.
Use to warm-up, stretch and develop muscles.
Great for practicing form

Size : 20m X 15cm X 0.2mm



[LB-L]
Yellow

[LB-H]
Green

KIDS BOW SET

- ⊙ BOW - 1EA
- ⊙ SAFETY ARROW - 6EA
- ⊙ TARGET BOARD 430mm - 1EA
- ⊙ QUIVER - 1EA
- ⊙ MAGNETIC DART - 8EA



[YB-A]



Size : 414mmX694mm [YB-A]

STRAFE BOWSTRING

67% SK75 dyneema, 33% vectran
Half the strand size of 450 plus
Slightly higher arrow speed
Higher strand count improves flexibility.
Looks great for multi-colored strings

No creep : completely stable
Recommended strands : 22 / 24
Approx ft / lb waxed : 8800
Speed size : 1lb



[SRF]

DACRON BOWSTRING

Strings : Meticulously ready made string
RECURVEBOW & TRADITIONAL BOW & CROSSBOW

Material : DACRON STRING & NYLON SERVING
Serving color : Red/Blue/Green/Yellow/White/Black



[DC-W]



[DC-B]

PHONE RING



[PHR-A]

[PHR-B]

[PHR-C]

CLOCK



[CLK]

CLOTHES

Size : S / M / L / XL / XXL



[FT-A]



[FT-B]



[FT-C-1]
COLOR : Black / White



[FT-C-2]



[FT-D]



[FT-E]

CAP *New*

Color : NAVY / WHITE



[FC-A]



[FC-B]



[FC-C]



[FC-D]



[FC-E]

SOCKS *New*



[SO-A]



[SO-B]



[SO-C]



[SO-D]

UMBRELLA *New*

length : 1m
opened size : 1m 60cm



[UMB]





Shooting with NANO-PRO arrow in 2012 LONDON OLYMPIC.



*ITALY: 2012 LONDON Olympic
Gold Medalist*

*- Michele Frangilli
with NANO-PRO*



NANO-PRO

Nano-Pro™ Nano-Pro is our newest nano-carbon arrow designed specifically for FITA, NAA, long-distance field shooting. Engineered with incredibly light yet strong 46-ton carbon, Nano-Pro recovers even faster out of the bow than Nano-XR while delivering the flattest trajectory and superior down range accuracy. It has the smallest diameter of any of our target arrows, which means, it nearly eliminates cross-wind drift. And unlike aluminum core arrows, Nano-Pro won't take a set (permanent) bend.

Spine-Selected for a consistent matched set.

FIVICS Pin Nock

This universal pin nock fits all standard pin nock adapters. It is made from a durable polycarbonate material that performs shot after shot.

Size: S / L

Color:



NANO-PRO Components

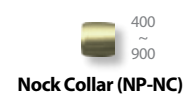

Shaft Size / Qty	ShWeight (Grain)	Spine	Diameter
900 / 12pk	5.3	900	0.177"
800 / 12pk	5.7	800	0.180"
750 / 12pk	6.0	750	0.183"
700 / 12pk	6.2	700	0.184"
650 / 12pk	6.4	650	0.186"
600 / 12pk	6.8	600	0.190"
550 / 12pk	7.1	550	0.193"
500 / 12pk	7.5	500	0.196"
450 / 12pk	8.0	450	0.200"
400 / 12pk	8.6	400	0.205"



NANO-XR

Nano-XR™ Introduced in 2007, Nano-XR was the first target arrow engineered from 40-ton carbon to deliver superior down-range accuracy, strength and consistency shot after shot. It's ultra small diameter dramatically reduces cross-wind drift and is the ideal arrow for FITA, NAA and NFAA long-distance shooting. In side-by-side tests, Nano-XR consistently outperformed comparable aluminum core/ carbon arrows in strength, recovery out of the bow, consistency, and velocity. In only its first year on the market, Nano-XR won the gold medal at the 2007 FITA world championship.

Spine-Selected for a consistent matched set.

FIVICS Pin Nock

This universal pin nock fits all standard pin nock adapters. It is made from a durable polycarbonate material that performs shot after shot.

Size: S / L

Color:



NANO-XR Components

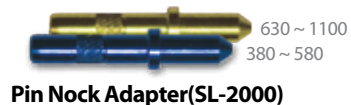

Shaft Size / Qty	ShWeight (Grain)	Spine	Diameter
1100 / 12pk	4.9	1100	0.181"
1000 / 12pk	5.2	1000	0.184"
900 / 12pk	5.5	900	0.186"
830 / 12pk	5.8	830	0.189"
730 / 12pk	6.2	730	0.191"
680 / 12pk	6.4	680	0.194"
630 / 12pk	6.6	630	0.196"
580 / 12pk	7.2	580	0.201"
530 / 12pk	7.5	530	0.203"
490 / 12pk	7.8	490	0.205"
450 / 12pk	8.1	450	0.208"
410 / 12pk	8.6	410	0.212"
380 / 12pk	9.0	380	0.214"



ZEILO (Intermediate)

ZEILO is the target arrow for youths. NEW

A cross weave of pure carbon layer gives it's unequaled strength, even on lightweight pure carbon arrows. This cross-woven method of construction is proven to deliver exceptional strength without adding weight.

FIVICS Pin Nock

This universal pin nock fits all standard pin nock adapters. It is made from a durable polycarbonate material that performs shot after shot.

Size: S / L

Color:



Available in two size: #1 fits 12-18 strand strings
#2 fits 20-24 strand strings

ZEILO Components



Stainless Steel Target Point (SN-1000)



Pin Nock Adapter (SI-1000)



FIVICS Pin Nock (PI-N)

Shaft Size	ShWeight (Grain)	Spine	Recommended Point Weight Range
500	9.22	500	110g / 120g
600	8.76	600	110g / 120g
700	8.18	700	110g / 120g
800	7.61	800	110g / 120g
900	7.26	900	110g / 120g
1000	6.97	1000	110g / 120g
1100	6.72	1100	110g / 120g
1200	5.59	1200	110g / 120g
1300	6.54	1300	110g / 120g
1400	6.26	1400	110g / 120g
1500	6.07	1500	110g / 120g

X-NET Point and reverpin is designed for X-10 arrows



Stainless Steel Target Point (SN-X10)



Pin Nock Adapter (SI-X10)



FIVICS Pin Nock (PI-N)

SIZE: 120g, 110g, 100g, 90g

COLOR: Gold, Blue, Red

COLOR: Yellow, Red, Green, Blue

FIVICS Target Arrow Shaft Selection Guide

Adjusted Bow Draw Weight

BowDrawWeight	23"	24"	25"	26"	27"	28"	29"	30"	31"	32"	33"
13~15 lbs.	ZL1500	ZL1500	ZL1500	ZL1400	ZL1300	TP1200 ZL1200	NX1100 TP1100 ZL1100	NX1000 TP1000 ZL1000	NX900 TP900 ZL900	NP900 NX830 TP800 ZL800	NP800 NX780 TP700 ZL700
16~18 lbs.	ZL1500	ZL1500	ZL1400	ZL1300	TP1200 ZL1200	NX1100 TP1100 ZL1100	NX1000 TP1000 ZL1000	NX900 TP900 ZL900	NP900 NX830 TP800 ZL800	NP800 NX780 TP700 ZL700	NP750 NX730 TP700 ZL700
19~21 lbs.	ZL1500	ZL1400	ZL1300	TP1200 ZL1200	NX1100 TP1100 ZL1100	NX1000 TP1000 ZL1000	NX900 TP900 ZL900	NP900 NX830 TP800 ZL800	NP800 NX780 TP700 ZL700	NP750 NX730 TP700 ZL700	NP700 NX680 TP600 ZL800
22~24 lbs.	ZL1400	ZL1300	TP1200 ZL1200	NX1100 TP1100 ZL1100	NX1000 TP1000 ZL1000	NX900 TP900 ZL900	NP900 NX830 TP800 ZL800	NP800 NX780 TP700 ZL700	NP750 NX730 TP700 ZL700	NP700 NX680 TP600 ZL800	NP650 NX630 TP600 ZL600
25~27 lbs.	ZL1300	TP1200 ZL1200	NX1100 TP1100 ZL1100	NX1000 TP1000 ZL1000	NX900 TP900 ZL900	NP900 NX830 TP800 ZL800	NP800 NX780 TP700 ZL700	NP750 NX730 TP700 ZL700	NP700 NX680 TP600 ZL600	NP650 NX630 TP600 ZL600	NP600 NX580 TP500 ZL500
28~30 lbs.	TP1200 ZL1200	NX1100 TP1100 ZL1100	NX1000 TP1000 ZL100	NX900 TP900 ZL900	NP900 NX830 TP800 ZL800	NP800 NX780 TP700 ZL700	NP750 NX730 TP700 ZL700	NP700 NX680 TP600 ZL600	NP650 NX630 TP600 ZL600	NP600 NX580 TP500 ZL500	NP550 NX530 TP500
31~33 lbs.	NX1100 TP1100 ZL1100	NX1000 TP1000 ZL1000	NX900 TP900 ZL900	NX830 TP800 ZL800	NX780 TP700 ZL700	NX730 TP700 ZL700	NX680 TP600 ZL600	NX630 TP600 ZL600	NX580 TP500 ZL500	NP550 NX530 TP500	NP500 NX490 TP400
34~36 lbs.	NX1000 TP1000 ZL1000	NX900 TP900 ZL900	NP900 NX830 TP800 ZL800	NP800 NX780 TP700 ZL700	NP750 NX730 TP700 ZL700	NP700 NX680 TP600 ZL600	NP650 NX630 TP600 ZL600	NP600 NX580 TP500 ZL500	NP550 NX530 TP500	NP500 NX490 TP400	NP450 NX450 TP400
37~39 lbs.	NX900 TP900 ZL900	NP900 NX830 TP800 ZL800	NP800 NX780 TP700 ZL700	NP750 NX730 TP700 ZL700	NP700 NX680 TP600 ZL600	NP650 NX630 TP600 ZL600	NP600 NX580 TP500 ZL500	NP550 NX530 TP500	NP500 NX490 TP400	NP450 NX450 TP400	NP400 NX410 TP300
40~42 lbs.	NP900 NX830 TP800 ZL800	NP800 NX780 TP700 ZL700	NP750 NX730 TP700 ZL700	NP700 NX680 TP600 ZL600	NP650 NX630 TP600 ZL600	NP600 NX580 TP500 ZL500	NP550 NX530 TP500	NP500 NX490 TP400	NP450 NX450 TP400	NP400 NX410 TP300	NX380
43~45 lbs.	NP800 NX780 TP700 ZL700	NP750 NX730 TP700 ZL700	NP700 NX680 TP600 ZL600	NP650 NX630 TP600 ZL600	NP600 NX580 TP500 ZL500	NP550 NX530 TP500	NP500 NX490 TP400	NP450 NX450 TP400	NP400 NX410 TP300	NX380	



HIGH FIVE VICTORY



**ASIAN FIRST
TARGET FACE LICENSED
MANUFACTURER BY FITA**

WATER PROOF TARGET FACE

FIVICS
ARCHERY PRODUCTS
FAX: 82-31-245-4596
WWW.FIVICS.COM
MADE IN KOREA

OUTDOOR TARGET FACE

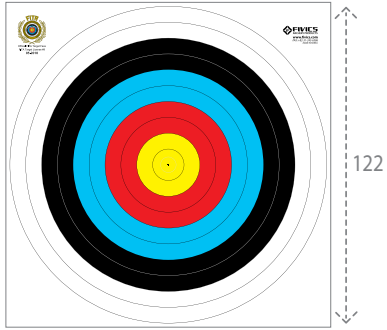

Name : OUTDOOR 122cm Target Face [PT 001]
Range : 90m / 70m / 60m
Mark dimension : 122cm X 122cm
Total dimension : 125cm X 125cm (width/length)

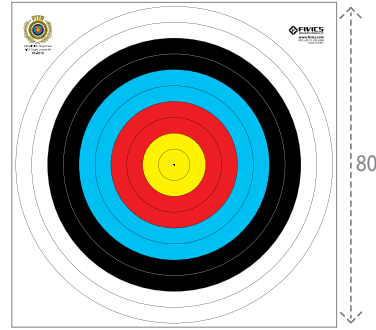

Name : OUTDOOR 80cm Target Face [PT 002]
Range : 50m / 30m
Mark dimension : 80cm X 80cm
Total dimension : 83cm X 83cm (width/length)



Name : OUTDOOR 60cm Target Face [PT 003]
Range : 25m
Mark dimension : 60cm X 60cm
Total dimension : 63cm X 63cm (width/length)

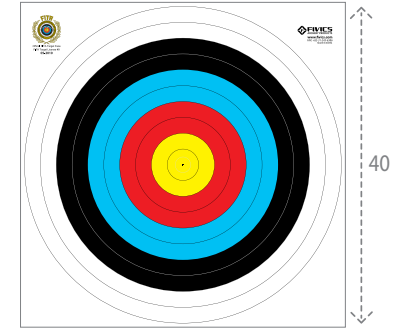

Name : OUTDOOR 40cm Target Face [PT 004]
Range : 18m
Mark dimension : 40cm X 40cm
Total dimension : 43cm X 43cm (width/length)



Name : OUTDOOR 40cm-5ring Target Face [PT 005]
Range : 30m / 20m
Mark dimension : 40cm X 40cm
Total dimension : 43cm X 43cm (width/length)



Name : OUTDOOR(3X40W) Triangular Target face(5Line) [PT 006]
Range : 30m / 20m
Mark dimension : (40cm-Center X 3Target)
Total dimension : 85cm X 85cm (width/length)



Name : OUTDOOR(4X40w) Target face(5Line) [PT 007]
Range : 30m / 20m
Mark dimension : (40cm-Center X 4Target)
Total dimension : 93cm X 85cm (width/length)

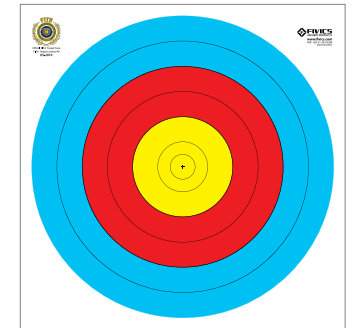

Name : OUTDOOR 48cm-6ring Target Face [PT 007A]
Range : 50m
Mark dimension : 48cm X 48cm
Total dimension : 51cm X 51cm (width/length)

OUTDOOR TARGET FACE



Name : OUTDOOR(3X48W) Triangular Target face(6Line) [PT 007A3]
 Range : 50m
 Mark dimension : (48cm-Center X 3Target)
 Total dimension : 99cm X 98.5cm (width/length)



Name : OUTDOOR(4X48W) Triangular Target face(6Line) [PT 007A4]
 Range : 50m
 Mark dimension : (48cm-Center X 4Target)
 Total dimension : 102cm X 105cm (width/length)

INDOOR TARGET FACE

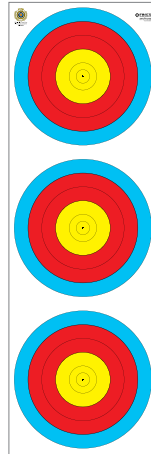

Name : INDOOR 20cm(3X20W) Target Face(18m) [PT 008]
 Range : 18m
 Mark dimension : 20cm X 3Target
 Total dimension : 23cm X 67cm (width/length)



Name : INDOOR 12cm(3X20W) Target Face(18m) [PT 010]
 Range : 18m
 Mark dimension : 20cm X 12Target
 Total dimension : 103cm X 67cm (width/length)

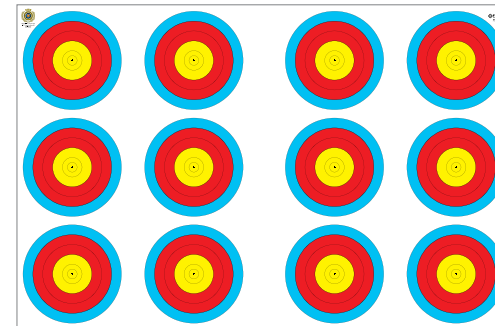
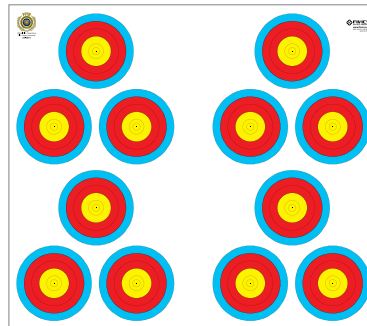

Name : INDOOR 20cm Triangular Triple Target Face [PT 011]
 Range : 18m
 Mark dimension : 20cm X 3 X 12Target
 Total dimension : 97cm X 85cm (width/length)

STICKER TARGET FACE

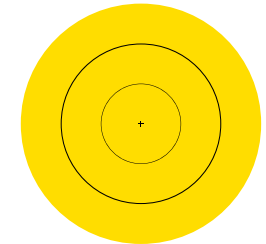

Name : Sticker Target Face [PT 018]
 Range : 90m / 70m / 60m
 Mark dimension : 15.8cm X 15.8cm

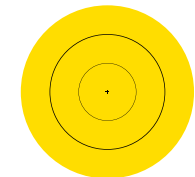

Name : Sticker Target Face [PT 019]
 Range : 50m / 30m
 Mark dimension : 24.3cm X 24.3cm

TRAINING TARGET FACE



Name : TRAINING 80cm-CenterSpot Target Face(8Line) [PT 012]
 Range : 50m/30m/20m
 Mark dimension : 24cmX24cm
 Total dimension : 32cmX32cm(width/length)



Name : TRAINING 122cm-CenterSpot Target Face(7Line) [PT 013]
 Range : 90m/70m/60m
 Mark dimension : 48.8cmX48.8cm
 Total dimension : 61cmX61cm(width/length)

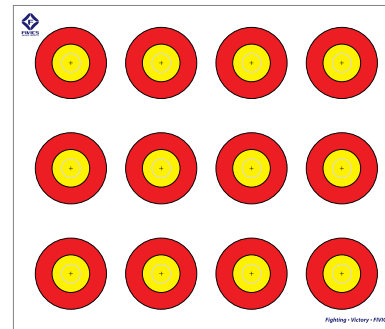

Name : TRAINING Target Face [PT 020]
 Mark dimension : 52mmX52mm
 Total dimension : 282mmX238mm(width/length)

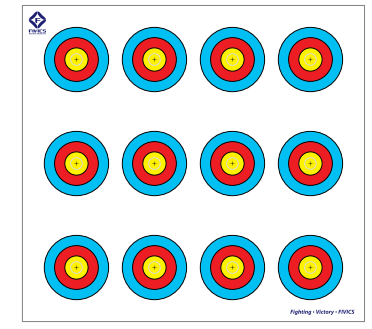

Name : TRAINING Target Face [PT 021]
 Mark dimension : 48mmX48mm
 Total dimension : 250mmX231mm(width/length)

FIELD TARGET FACE

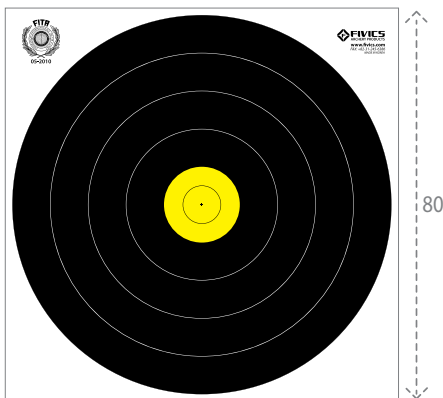

Name : FIELD 80cm Target Face [PT 014]
 Mark dimension : 80cmX80cm Target
 Total dimension : 83cmX83cm(width/length)

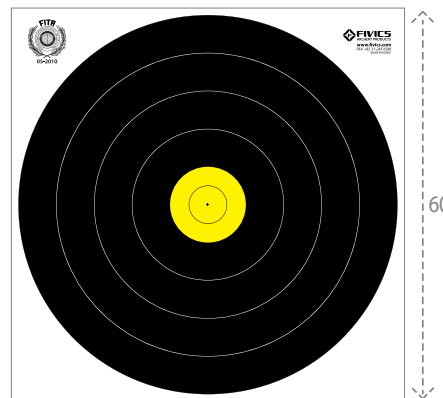

Name : FIELD 60cm Target Face [PT 015]
 Mark dimension : 60cmX60cm Target
 Total dimension : 63cmX63cm(width/length)

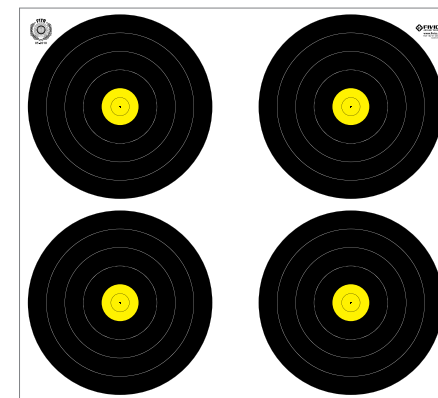

Name : FIELD 40cm(4X40W) Target Face [PT 016]
 Mark dimension : 40cmX40cm
 Total dimension : 93cmX85cm(width/length)

FOAM TARGET FACE

Combination of durable form and Smart technology of FT system.
 No impurities on FIVICS foam target,
 No glues used.
 Simple replacement of the incore.
 Easy arrow removal.
 Water proof.
 The surface of the target foam is strong and hard enough.
 Don't worry about any weather condition with FIVICS target face.
 It will fit all of your needs.

- **Name : A Foam Target**
 Exterior A
 Size : 125cmX125cmX18cm
 Weight : 20.4kg
- Incore A
 Size : 63cmX63cmX33cm
 Weight : 13.6kg

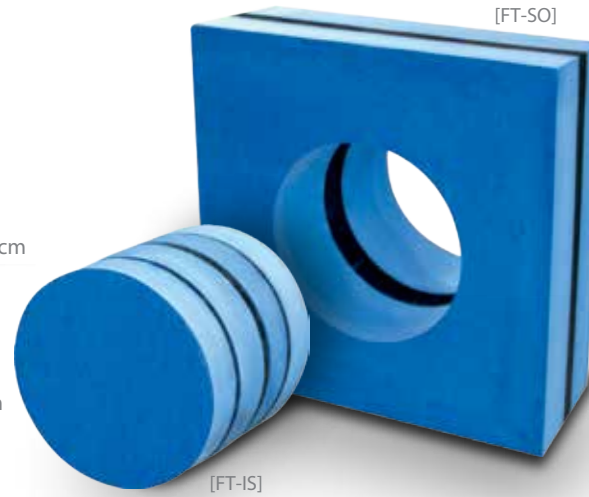

- **Name : B Foam Target**
 Exterior B
 Size : 95cmX95cmX24cm
 Weight : 22.9kg
- Incore B
 Size : 24cm X 24cm X 50cm
 Weight : 1.4kg

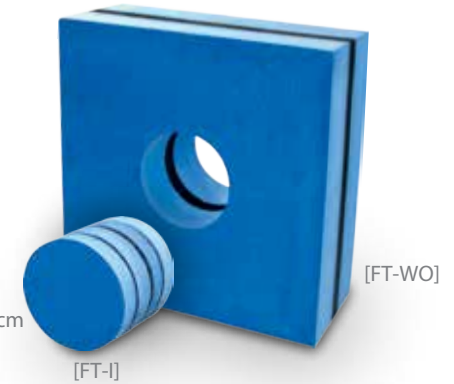

ACADEMIC TARGET FACE



Name : OUTDOOR Target Face [PT 017]
 Range : 70m
 Mark dimension : 97.2cmX97.2cm
 Total dimension : 103cmX103cm(width/length)

PERFECT SCORE SHEET



Name : Perfect score sheet
 Total dimension : A4(21 X 29.7)
 Applicable under any weather condition
 Ink not smudged

- **Name : C Foam Target**
 Exterior C
 Size : 104cmX104cmX9cm
 Weight : 9.5kg



[FT-FF]

World Top shooter's with FIVICS

HIGH FIVE VICTORY!!



