

EN

2014
PRODUCT GUIDE
NEW & UNCOMPARABLE IDEA



You, make your dreams come true.....
FIVICS will be with you.

A great while ago, a boy dreamed of putting a gold medal around his neck, shot 300 to 500 arrows per day. And he imagined that he would put a gold medal around his neck in his dreams every night.

However, unfortunately, the boy could not make his dream come true. After that, the boy chose a job to help his juniors make their dreams that he could accomplish come true. And he is now absorbed in grasping and improving inconvenience of archers constantly.

The FIVICS team is led by the boy. FIVICS consisted of the executives and staff members from the archers who most understand archery. FIVICS' starting point was to try to make products which improve records by maximizing the characteristics of each archery product on the basis of provision of elements which are truly necessary for archery based on understanding archers exactly.

FIVICS has made efforts to do creative development and research, produced the high quality products with many patents, and continued to challenge constantly still now since it was established in 2002.

FIVICS President, CEO
Baek, Jong Dae

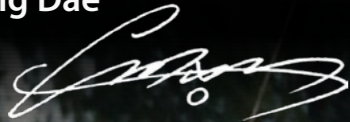

1985~2000



Sales
 General Manager
HAN SANG BONG

Design Dept.
 Assistant Manager
KANG YONG SEON

Planning Dept.
 Assistant Manager
YOU HAN CHUL

FIVICS President, CEO
BAEK JONG DAE

R&D Dept.
 Manager
YOON GEON HOO

Design Dept.
 Manager
DANIEL KIM



Administration Dept.
 Manager
KIM DA YEON

International Sales
 Manager
CLAIRE KO

Administration
YOU HAN KYUNG

International Sales
 assistant Manager
YOO EUN KYUNG

General Affairs Dept.
 Manager
YOU BO YOUNG

ADVANCED

SPACE AGE TECHNOLOGY

“The products which consider the future after 100 years” (All-time value)

FIVICS has continued research and tests by the new swift of ideas about archery with the differentiated challenging spirit and the creative spirit. We have the best technical skills which use new materials and high tech equipment in the world. And professional researchers are devising independent methods to be successful in make items that nobody did or which are worthy doing.

We think that vitality to promote things with new ideas and keen sense forgetting an old way of thinking is needed and there is no law against continuing win games tomorrow because we win today. So we don't satisfy the present. We are constantly challenging and working with passion like the words, "improvement is forever and infinite."

We have continued to research products asking ourselves a question "what's the better way to keep the trust," "FIVICS will make innovative products by the switch of ideas." repeatedly.

FIVICS thinks that aiming at the industry's common sense or average values is like taking a ship which is sinking. FIVICS will be immersed in using wisdom, not money with ideas and passion which are different from those of other companies.

We will always do our best to reward your constant concern and encouragement.

All the executives and staff members of FIVICS Archery Co., Ltd.

- 01 computerized numerical control process for component of riser
- 02 CNC process of riser
- 03 riser in process of anodizing
- 04 test for riser solidity
- 05 analysis of vibration with superhigh speed camera
- 06 analysis of limb's load curve
- 07 assemble process of components
- 08 sewing product manufacturing processes
- 09 assemble process of carbon part
- 10 carbon revision process
- 11 FIVICS China Factory

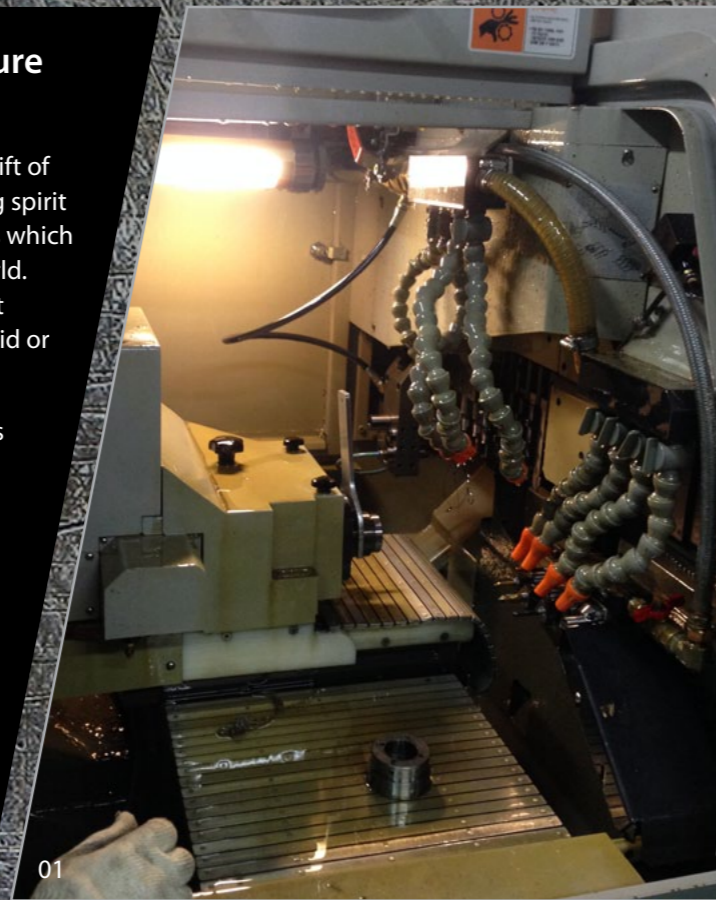

01

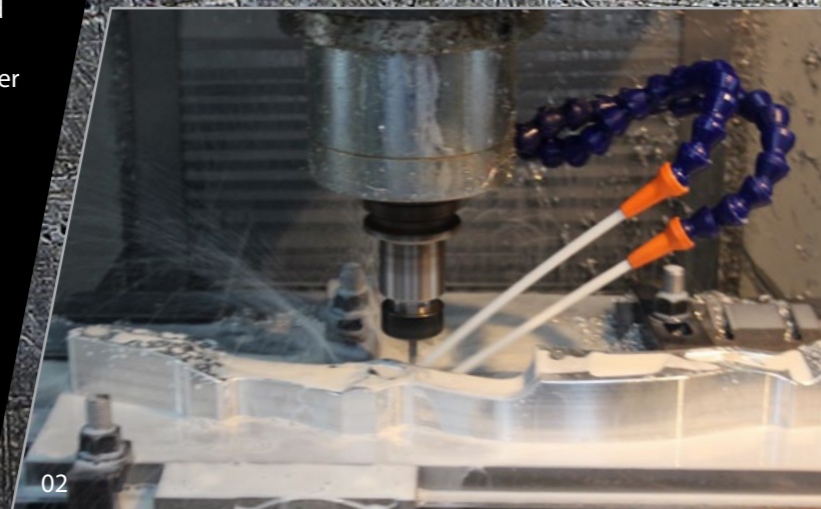

02



03



04

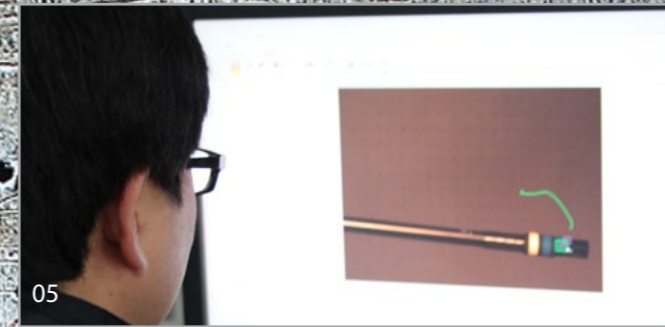

05



06



07



08



09



10



11

NEW



- Precision • Stability
- Accuracy • Consistency

Innovation of 100% CNC precision processing

FIVICS prepared the best high tech CNC milling production facilities in the world.

PLATINA is processed by the upgraded precision processing technology. And accuracy is very excellent as it generally solved irregular surface processing defects and errors. Therefore, any minute processing error which could occur in processing cannot be permitted.

So nearly perfect limbs and fixer alignment can be done.

The best quality and unchangeable surface

HARD ANODIZING

Surface treatment method technology

Anodic coating surface treatment method's wear resistance is excellent because it's very hard.

FIVICS made you choose the best bow by increasing the surface's strength and make it not be changed by temperatures and external shocks with the hard anodizing technology by considering the best quality and unchangeable surface. You can feel the differences of refined use as we released the best quality riser of aluminium 6061 that harder precision processing is done.

SPECS

LENGTHS	25", 27" HARD ANODIZING
MATERIAL	Aluminum(6061), BTR300 Rubber
WEIGHT	25" 1,320g / 27" 1,365g
TYPE	RH / LH

HARD ANODIZED COLOR



TECHNOLOGY

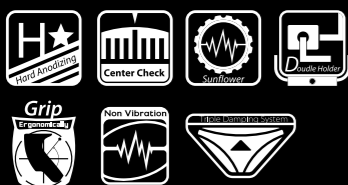

27"

[HM-PL7]

[HM-PL]

25"

Clicker Extension

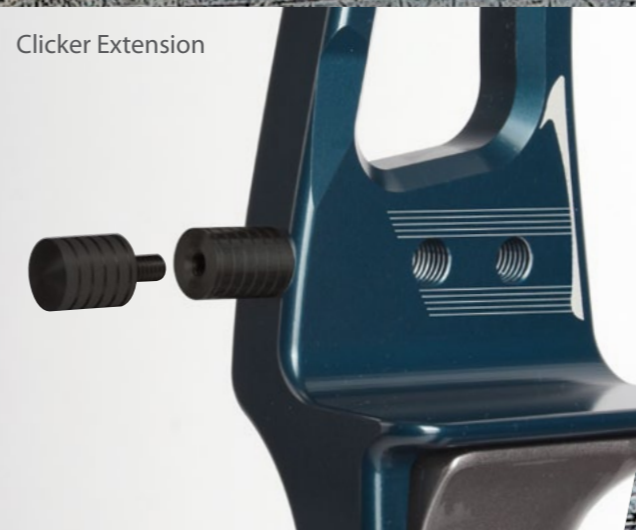

Hard Anodizing

Sunflower Damping System

"Sunflower Damping System" is a primary vibration control system.

It is simpler and easier to adjust the center.

LIMB/RISER ALIGNMENT

mission?

1. center control system without disjoint limbs and riser
2. easiest adjustment without extra tools
3. untroubled adjustment system by bow's impact

You can simply adjust the center-shot without unstringing the bow.

Easy center control system with simple way of screw control method
If you want to move the limbs to the left and right (same as lower limb)

1. loosen a (A) right screw
2. Loosen (C) and tighten (B), then Center is moving to direction (B)

Loosen (B) and tighten (C), then Center is moving to direction (C)

After Set-up, please always tighten the bolt in the opposite side

3. tighten a (A) back screw

Don't forget to double-check the bolts fastened.



Sunflower System



Double holding Center locking

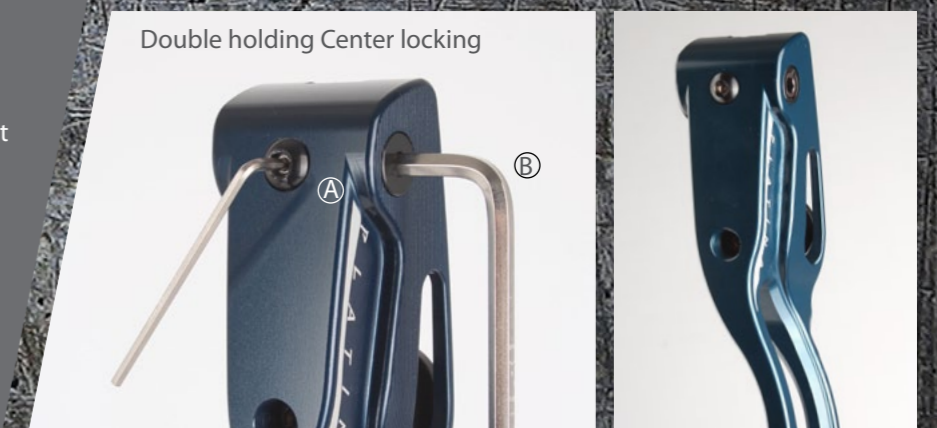

Detail checking line



NEW



- Stability
- Precision
- Consistency
- Stabler design

Innovation of 100% CNC precision processing

HYDRO is processed by the upgraded precision processing technology. And accuracy is very excellent as and it generally solved irregular surface processing defects and errors.

Therefore, any minute processing error which could occur in processing cannot be permitted. So nearly perfect limbs and fixer alignment can be done.

HIGH QUALITY ANODIZING

SPECS

LENGTHS	25" High Quality Anodizing
MATERIAL	Aluminum(6061), BTR300 Rubber
WEIGHT	1,290g
TYPE	RH / LH
COLOR	BLACK, BLUE, RED, PINK, YELLOW, (Anodizing) GREEN

ANODIZED COLOR



TECHNOLOGY

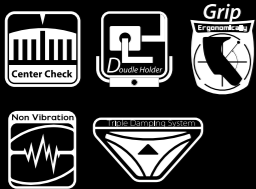

25" ANODIZING

Clicker Extension



High Quality Anodizing

It is simpler and easier to adjust the center.

LIMB/RISER ALIGNMENT

mission?

1. center control system without disjoint limbs and riser
2. easiest adjustment without extra tools
3. untroubled adjustment system by bow's impact

You can simply adjust the center-shot without unstringing the bow. Easy center control system with simple way of screw control method. If you want to move the limbs to the left and right (same as lower limb)

1. loosen a (A) right screw
2. Loosen (C) and tighten (B), then Center is moving to direction (B)

Loosen (B) and tighten (C), then Center is moving to direction (C)

After Set-up, please always tighten the bolt in the opposite side

3. tighten a (A) back screw

Don't forget to double-check the bolts fastened.

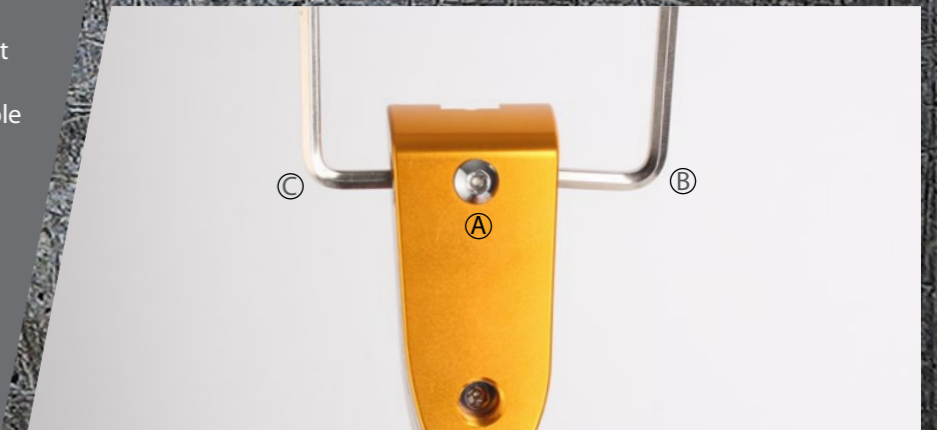

Detail checking line

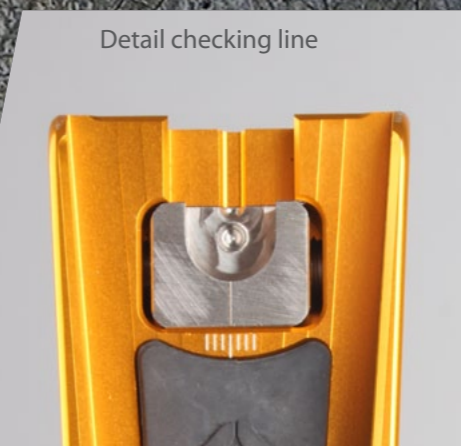

Double holding Center locking

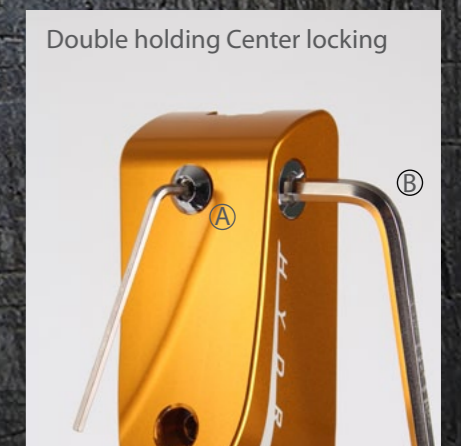

UPGRADE

SRV RISER

distortional failure. light and detail designed, SRV

- Stability
- Accuracy
- Consistency
- Stylish design
- 100% CNC milling processing

CNC milling processing precision

FIVICS solved the bended and twisted riser which could occur in process with the world's best high tech CNC milling production facilities and technologies. So nearly perfect limbs and fixer alignment can be done.

Choose the length of the riser

Individual archers can choose the best bows by considering their physical differences including the distance to draw bows by releasing the 23 inch long riser as well as the existing 25 inch long riser.

SPECS

LENGTHS	23", 25"
MATERIAL	Aluminum(6061), Rubber
WEIGHT	23" 1,220g / 25" 1,280g
TYPE	RH / LH
COLOR (Painted)	BLACK, BLUE, RED, YELLOW, GREEN, PINK, WHITE

PAINTED COLOR



TECHNOLOGY



Choose the high grip riser and the middle grip riser

The existing riser's grip has been formed by the same grip angle and line. However, FIVICS made individual archers choose the best bows by considering the physical differences by SRV's high grip riser and middle grip riser. For your guidance, the SRV high grip riser and the SRV middle grip riser were manufactured to have different grip lines and angles of the risers.



A Clicker Extension

B Automatic Arrow Guide

The easy system to put arrow without clicker

C Rest line

It was designed to remember and check rests' location when attaching and using them.

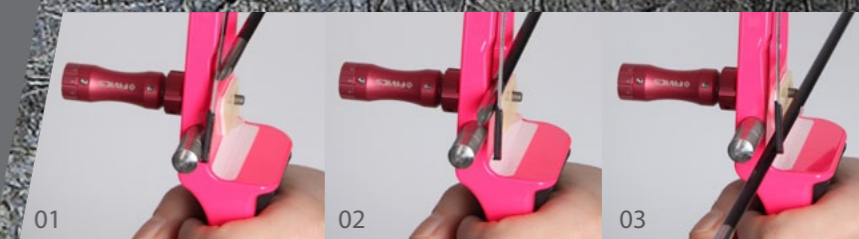
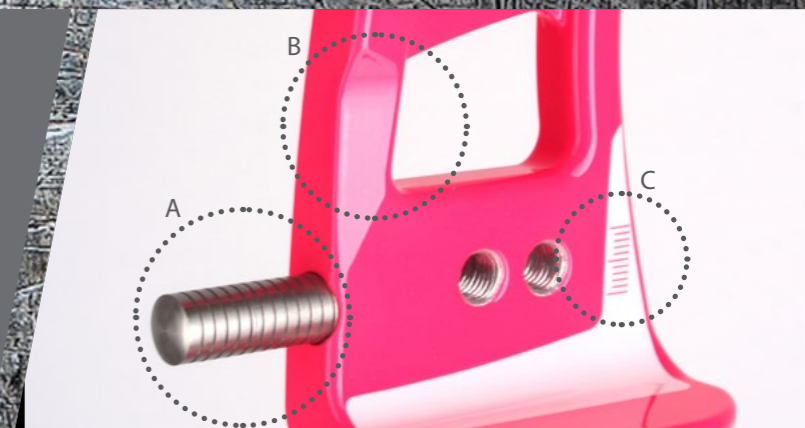

Triple damping system

The SRV riser provides clean shooting feeling for you by inserting rubber buffer in the grip center and the inside of upper and lower caps to control vibration and noise which could occur in shooting.



UPGRADE

FX1 RISER

TOP SHOOTER'S CHOICE

- Stability
- Accuracy
- Consistency
- Special design
- 100% CNC milling processing

CNC milling processing precision

FIVICS solved the bended and twisted riser which could occur in process with the world's best high tech CNC milling production facilities and technologies. So nearly perfect limbs and fixer alignment can be done.

Choose the material of the riser

The material of the existing 25 inch-long aluminium riser has been processed by 6061 materials. However, FIVICS' FX1 made individual archers choose the best bows by considering the physical differences by releasing the stronger riser which was processed by aluminium 7075 materials.

SPECS

LENGTHS	25"
MATERIAL	Aluminum(7075), Rubber
WEIGHT	1,310g
TYPE	RH / LH
COLOR (Painted)	BLACK, BLUE, RED, YELLOW, GREEN, PINK, WHITE

PAINTED COLOR



TECHNOLOGY



AL7075 RISER

Choose the high grip riser and the middle grip riser

The existing riser's grip has been formed by the same grip angle and line.

However, FIVICS made individual archers choose the best bows by considering the physical differences by FX1's high grip riser and middle grip riser.

For your guidance, the FX1 high grip riser and the FX1 middle grip riser were manufactured to have different grip lines and angles of the risers.



Pressure point direction

The existing riser's high and middle grips have been formed by the same grip angles and lines. So the high grip pressure pint could not be located in the outside of the center. FIVICS made the pressure point be located toward the center more certainly by removing the parts unnecessary for the location that archers' hands contact the riser grip parts. FIVICS' high grip which was especially made make archers keep their shoulders' angles easily when drawing their bows and was designed to reduce unnecessary force and fatigue.

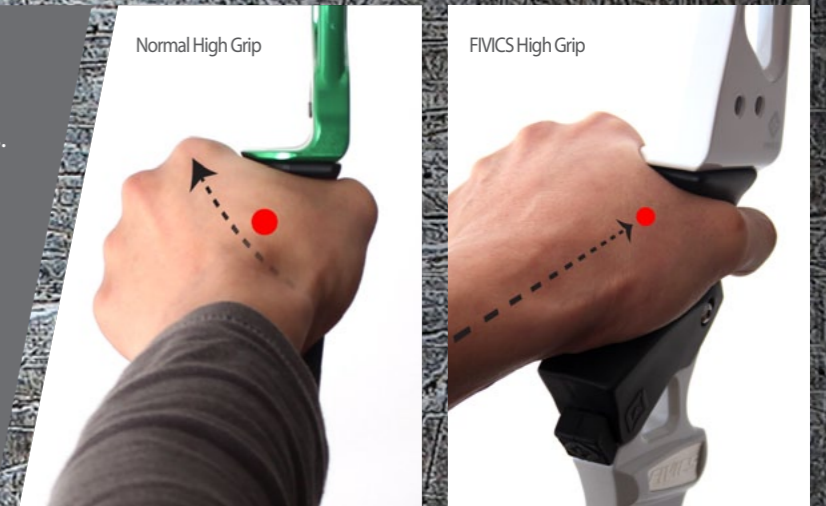

Ideal grip

FIVICS's grip makes archers have exact pressure points. And as it is especially designed by considering knuckles and their shoulders' angles and location, they can have comfortable and stable postures and increase concentration much more.



Triple damping system

The FX1 riser provides clean shooting feeling for you by inserting rubber buffer in the grip center and the inside of upper and lower caps to control vibration and noise which could occur in shooting.



NEW

TITAN

PURE

mission ? energy, speed, concentration, safety, durability

High Quality 3K Full Carbon Limbs TITAN

We will introduce TITAN which was made by FIVICS' new technology to you.

TITAN was a wing which was corrected, supplemented, and produced by support and a lot of feedback of the several top shooters in the world focusing on 'energy, speed, concentration, safety, and durability' that archers want.

So we are confident that TITAN will give professional archers better scores and satisfaction.

TITAN got to be released by FIVICS' own original creative spirit after research and development by receiving the concept and sense of wings that archers want.

FIVICS' FX1 and SRV RISER, FX1 and RX1 Limbs got to receive recognition in the World Cup and international championships as Chinese CUI Yuanyuan win the game in 2013. It received honourable mention from the archers in the world as they continued to win gold medals by using FIVICS' bows in the national games in the various countries.

"A newer and more excellent wing"

Therefore, FIVICS received a lot of support and feedback from the archers in the world to set and achieve the project to develop 'a newer and more excellent wing' in 2014.

FIVICS' newer and more excellent wing will deliver victories to the various archers in the world in 2014.

We actively recommend you to use High Quality 3K Full Carbon Limbs TITAN of the new concept that you want in 2014.

In addition to improving its high quality, reasonable prices

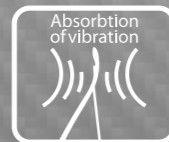

SPECS

Bow Length : 66", 68", 70"
Draw Weight (lbs.) : 28# ~ 48#

TECHNOLOGY

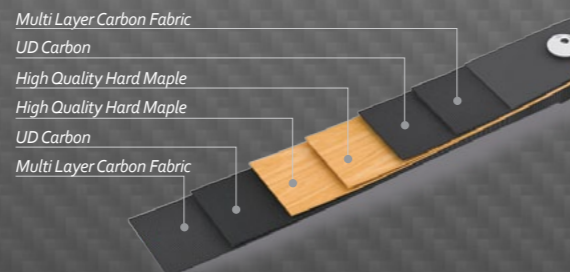

[LM-TP]

NEW

TITAN

BOLD

we have taken care to ensure that today TITAN BOLD professional limbs is also more competitive than ever. To ensure the highest quality, we developed with high quality of syntactic foam. High quality Syntactic foam and high quality carbon material are combined by FIVICS Archery's fine technology. The key to TITAN BOLD high quality limbs continued success is that everyone from design, to production, to merchandising and beyond works toward one goal: to provide archers with the most ideal high quality archery limbs

SPECS

Bow Length : 66", 68", 70"
Draw Weight (lbs.) : 28# ~ 48#

TECHNOLOGY

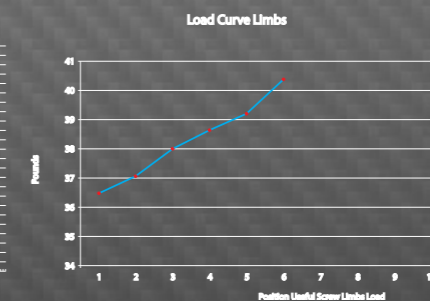
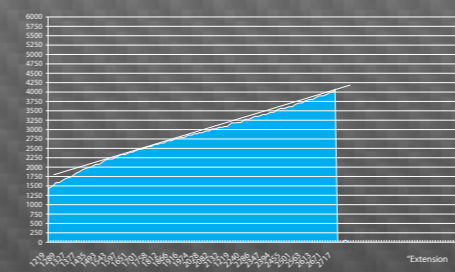
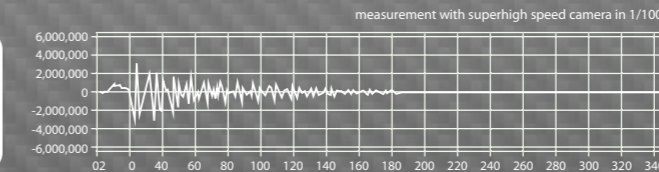
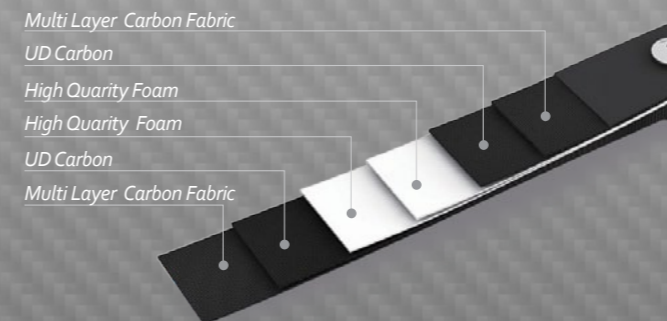

[LM-TB]

UPGRADE

MERIDIAN FX1

Multi carbon technology

FX1 which delivers explosive force and energy to arrows provides faster speed for them. The multi carbon technology increase the speed of arrows more and their consistent grouping by maximizing the force which is delivered to them as the wing and materials which provides cushioning the impact in proportion to the force. And design and materials by part in the wing part which were more reinforced extend its life.

Energy consistency, safety, and accuracy

Premium wood was used in Meridian FX1 for safety!

SPECS

It removes poor movement and makes archers shoot arrows accurately by maximizing shock absorption of the shooting moment by preventing vibration with multicross carbon and premium wood.

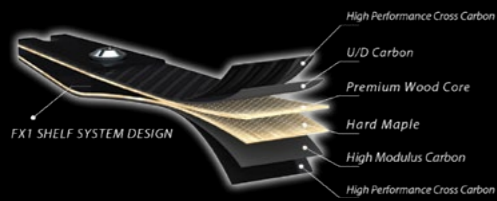

Available Lengths : 66" 68" & 70"
Available weights : 2# increments

CONSISTENCY, STABILITY, ACCURACY
...MERIDIAN FX1 & MERIDIAN RX1

TECHNOLOGY



[LM-FX1]

MERIDIAN RX1

FIVICS Meridian RX1 rejects comparison!

The multi carbon technology

It increased speed and energy consistency by integrating complex materials with the nano-technology.

Multi form core

It increased safety and smoothness by removing vibration as multi cross carbon and 'nanoform' are used in the inside. RX1 removes poor movement and makes archers shoot arrows accurately by maximizing shock absorption of the shooting moment.

SPECS

Stable and fast shooting is provided by using the high quality carbon and form-core to remove vibration.

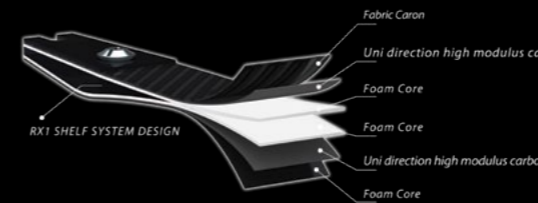

FORCE-DRAW CURVE

FIVICS *MERIDIAN FX1 / MERIDIAN RX1 Limbs medium length on 25" riser 40.3 lbs @ 28" / 30" / 32"

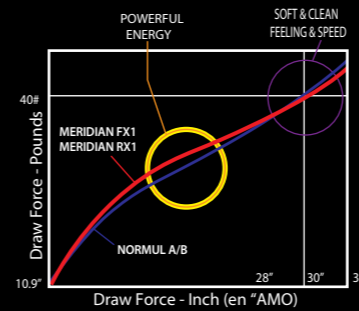

Draw Weight : 40.3 lbs @ 28"/30"/32"
Limb Length : medium (68" Bow Length on 25" Riser)
Brace Height : 7-3/4"-8-3/4" (depending on riser)
Physical Weight : 365 Gramm oz (pair)

TECHNOLOGY



[PG-FX1]

NEW

TAKEN-V

TAKEN-V Professional Limbs

TAKEN-V is completely new design to shoot the best performance. The latest technology is in a carbon layer and special design of limb curve line. We made this TAKEN-V limbs with 3K carbon, fabric woven carbon and UD Carbon. In a classic design, this limbs coordinates with the excellent conditions. Experience the highest quality like never before. We've made All our products in Korea and now our style is making its way to the World.

SPECS

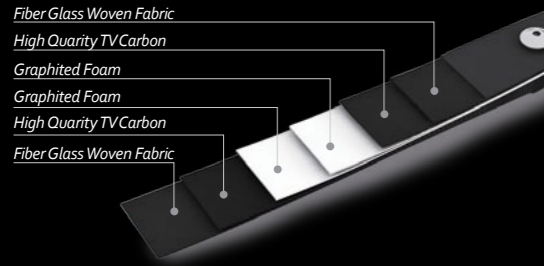

Bow Length : 66", 68", 70"
Draw Weight (lbs.) : 28# ~ 48#



TECHNOLOGY



PEGASUS

The wing obtained the perfect score of 360 points

Multi carbon technology

Pegasus Wing is the very stable wing with speed, accuracy, power, balance, and durability. It is very strong for twisting and the wing's movement is very stable in shooting as the strong elasticity of premium wood core is in fantastic harmony with glass fibre.

Superior stability

What's the multi core system?

It provides strong and fast shooting for archers by using the high quality carbon and premium wood-core.

SPECS

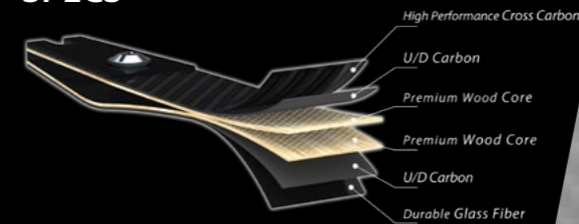

Bow Length : 66", 68", 70"
Draw Weight (lbs.) : 28# ~ 48#

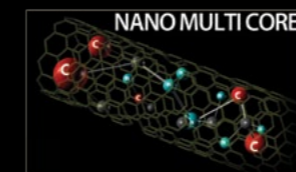

Premium Shooting Feeling

TECHNOLOGY



FV-200

CARBON , ALUMINUM SIGHT

It is very strong for twisting by FV carbon/aluminium extension.

There is no any noise and vibration because of the 3HD system and unique drawing locking system. You can adjust the head delicately by the upper and lower adjustable slides which are attached to it and the bolts to adjust the right and left of the sight pins can be tenderly and delicately adjusted.

SIZE Extention 9 inches

COLOR

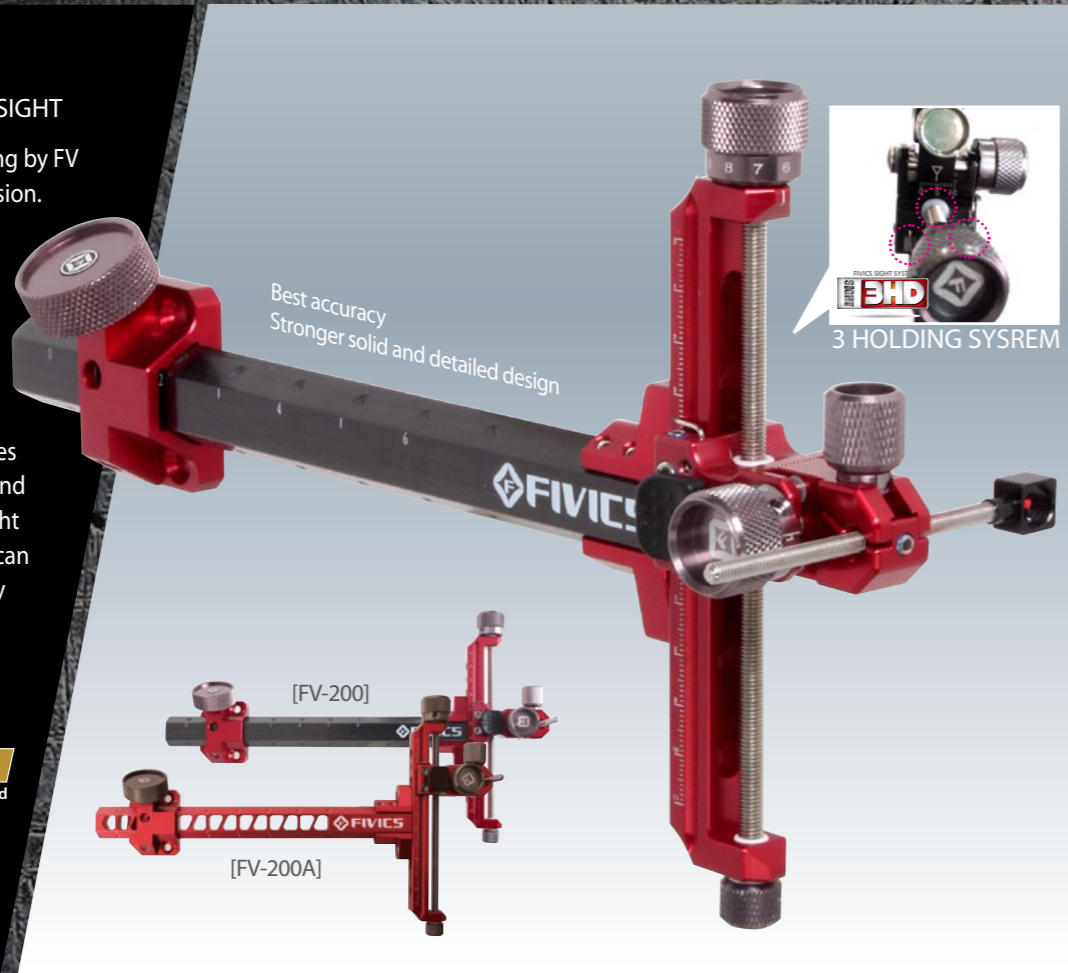

FV-100

CARBON , ALUMINUM SIGHT

It is very strong for twisting by FV carbon/aluminium extension.

There is no any noise and vibration because of the 3HD system and unique drawing locking system.

You can adjust the head delicately by the upper and lower adjustable slides which are attached to it and the bolts to adjust the right and left of the sight pins can be tenderly and delicately adjusted.

SIZE Extention 9 inches

COLOR

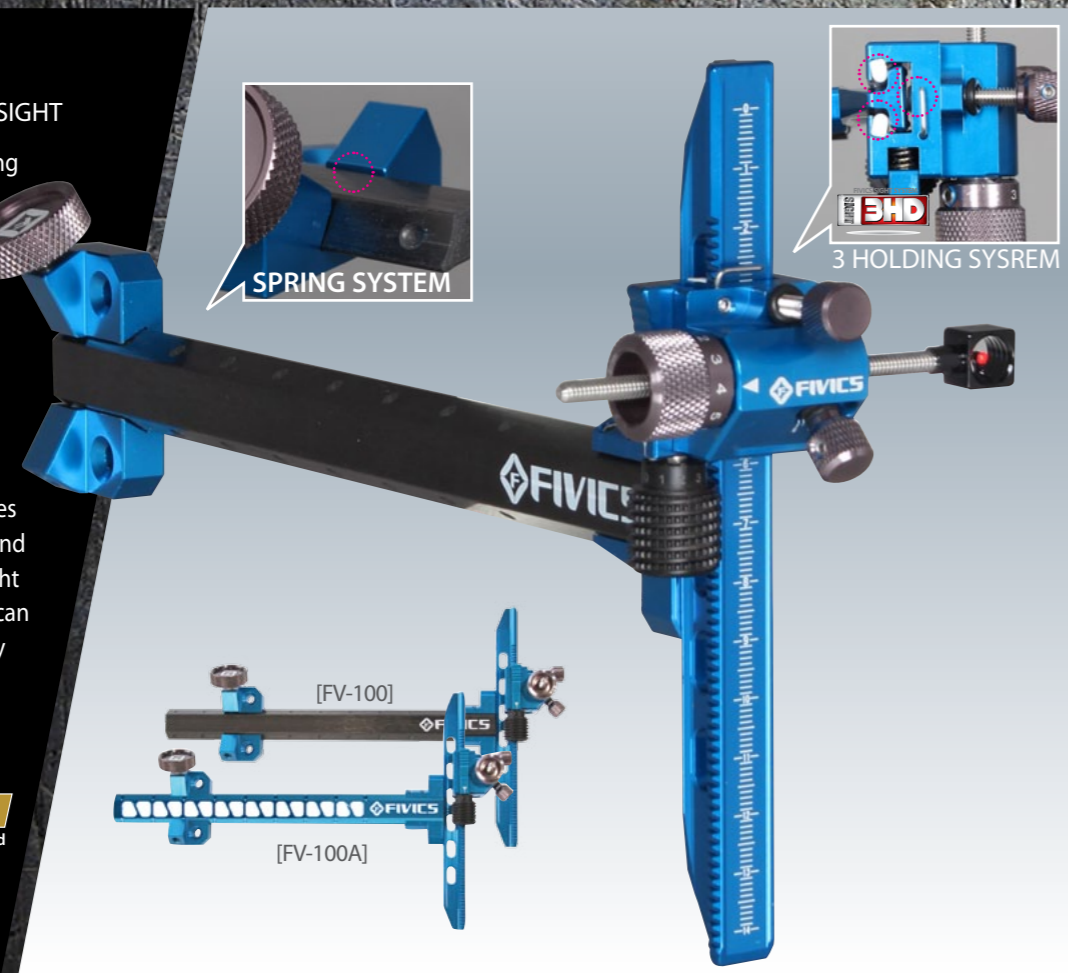

NEW COLOR SIGHT PIN

You can horizontality of the sight pins due to the color line in the external parts. You can take aim more stably and accurately in aiming.

SP-1 COLOR



SP-2 COLOR



COLOR LINE OUT SIDE

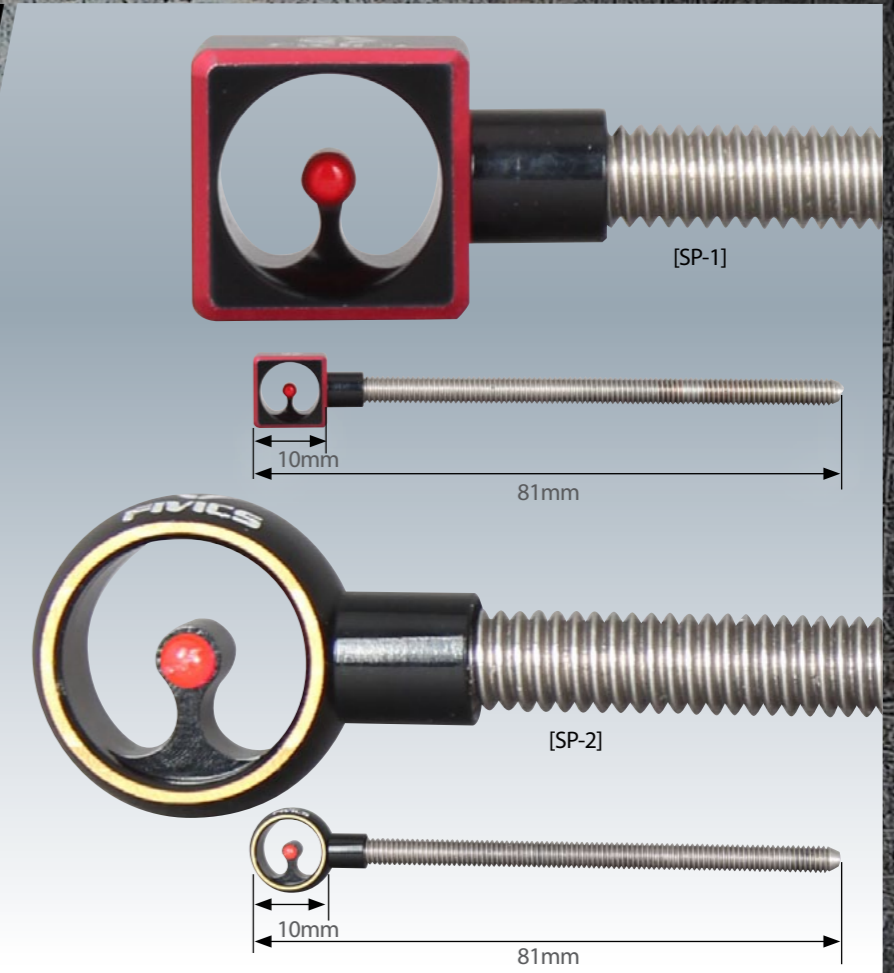

A Style

Well-arranged pocket system, durable case, fancy design
Size : 10.6"X7"X2.2"

COLOR



B Style

Compact designed sight case



SIGHT CASE

A+ Style

durable bigger case.
Size : 12.3"X8"X2.5"

COLOR



C Style

Handy sight protection case

COLOR





FIVICS has studied complexes which used carbon nanotube – epoxy composite non-conjugated polymer to make nano carbon stabilizers that applied carbon nanotube for many years. The property of matter of Epoxy manufactured by FIVICS only by utilizing carbon nanotube (CNT) and applied technologies maximized durability by increasing tensile strength by more than 30%. We obtained the standard manufacturing method including realization of uniform property of matter and mix of use and got to develop cex2000 stabilizer with innovative performance. For CEX2000 Stabilizer applied by utilizing carbon nanotube, reduction of vibration is very excellent.

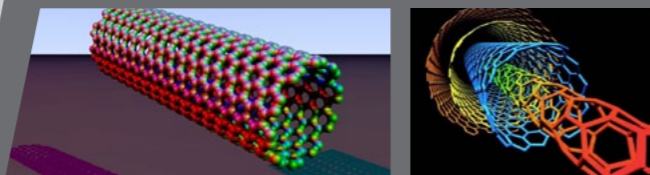

mission? "Lower vibration, shorter wave"

"It is light and strong" Please enjoy in shooting.....

NEW CEX2000 Stabilizer was manufactured by CNT high tech composite materials and was differentiated from the existing stabilizers as it was specially manufactured with carbon fabric focusing on development of 'low vibration, shorter wave' according to stabilizers' characteristics. It is general that 24 tons and 30 tons are applied to the existing stabilizers. However, CEX2000's feature is a very strong spine compared to high elasticity and specific weight by integrating high carbon of high elasticity with it.

And for manufacture of form, the legend stabilizer system which realized shorter wave and removes remained vibration by maximizing carbon pure density by minimizing contents of foreign substances (resin) through FIVICS' high pressure forming method in was realized.

It provides light and safe balance for you.

The thickness of carbon was designed to make long and short carbons be 1.5mm and extenders be 2mm as CXT carbon (CEX Technical). New CEX2000 prevents slipperiness when it is installed and optimized reflection of light of the stabilizers by using the high quality decal transfer paper and rubber coating technology and upgraded the dignity of the product. An aluminium cap used in the whole part was more accurately processed as it is done by the new machining center of FIVICS. Reinforcement of adhesive strength of shaft and cap is connected to more stable shooting as the inside of the cap is linear. It improved the aesthetic element by doing surface roughness.



[CX20-L]

Diameter : 20mm

Long Stabilizer	26", 28", 30", 34"
Side Stabilizer	10", 11", 12", 15"
Extender	4", 5", 6"



[CX20-E]

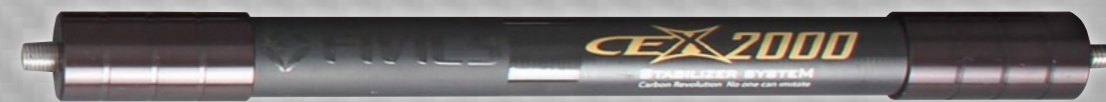

[CX20-S]



TECHNOLOGY



measurement with superhigh speed camera in 1/1000

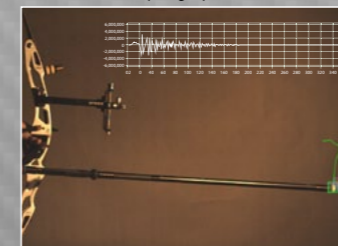

Gear2000



[GR-L]

Diameter : 20mm

Long Stabilizer	24", 27", 30"
Field Stabilizer	10", 12", 15", 18"



[GR-S]

TECHNOLOGY



STABILIZER PHOENIX

The problems of weights and vibration? Were already solved!

Stabilizer for game, 'Phoenix' was manufactured by the high quality high elasticity cross carbon with the diameter of 22mm.

Generally, compound archers are using stabilizers by hanging many weights, but there were any stabilizer to remove 'all the weights and vibration' in the past.

However, Phoenix Stabilizer for game removes weight and vibration, and even noise with strong spine.

And because it is light and very strong and strength is strong, all the male and female archers prefer it.

In addition, the aluminium cap attached to Phoenix Stabilizer can bear a lot of weight as it is not easily separated by the screw combination system.

Diameter : 22mm

Long Stabilizer	24", 27", 30", 34"
Side Stabilizer	10", 11", 12"
Extender	4", 5", 6"



- Highly elastic material
- Strong spine
- No noise, No vibration
- It's ok with lots of weights
- Great stability
- Light shaft

TECHNOLOGY



[PNX-L]

[PNX-E]

[PNX-S]

Stabilizer CEX7

Stabilizer for game CEX7 was manufactured by the high quality multilayer carbon with the diameter of 18.7mm.

CEX7 focuses on increase of safety by providing clean feeling concentrating on balance of bow speed and shooting balance in shooting. The CEX7 carbon balance system provides the best solidity and balance of weight for you.

And because it is light and very strong and the shaft's strength is strong, all the male and female archers prefer it.

In addition, the aluminium cap attached to CEX7 Stabilizer can bear a lot of weight as it is not easily separated by the screw combination system.

CEX7 Stabilizer is not easily separated because there is the screw in the end of the shaft and the cap.

Diameter : 18.7mm

Long Stabilizer	26", 28", 29", 30", 34"
Side Stabilizer	10", 11", 12"
Extender	4", 5", 6"

COLOR



TECHNOLOGY



[CE7-L]

[CE7-E]

[CE7-S]

Stabilizer CEX5

Stabilizer for game CEX5 was manufactured by the high quality UD and multilayer carbon with the diameter of 18.5mm.

It gives archers confidence as the product which passed the best level of difficulty. The best stabilizer controls vibration in proportion to speed. It even removes lesser wobble and vibration. It provides the best speed and stability for you. As it provides clean feeling for you focusing on bow speed and shooting balance in shooting, it focuses on increase of safety.

Diameter : 18.5mm

Long Stabilizer	26", 28", 29", 30", 34"
Side Stabilizer	10", 11", 12"
Extender	4", 5", 6"

COLOR



THE INNOVATION OF SHOOTING FEELING

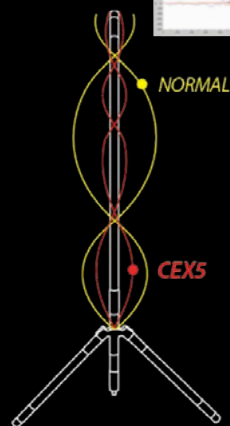
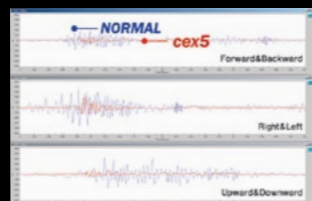

TECHNOLOGY



CEX2+

CEX2 is the product that many archers obtained gold medals in the Olympics and international championships. CEX2 is light and the shaft's strength is very strong because 1K high elasticity cross carbon with the diameter of 18.2mm was used. And the cap in the front of the long stabilizer provides higher shooting speed and balance for you as it is stainless. And the internal thickness of CEX2 extender 200% thicker than that of the existing products and effectively reduces shocks in shooting.

Diameter : 18.2mm

Long Stabilizer	24", 26", 27", 28", 29", 30"
Side Stabilizer	9", 10", 11", 12"
Extender	3", 4", 5", 6"

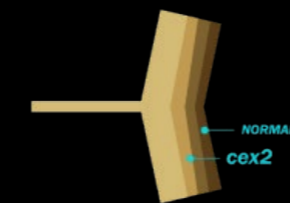
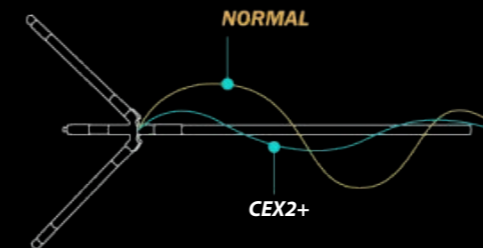

check over the Vibration (Bow Speed)

TECHNOLOGY



MAXPRO

Excellent elasticity

MAXPRO is light and has excellent elasticity stability.

The high tech materials were used as the composite materials which are now commercialized.

Maxpro was formed and manufactured by laminating the high tech materials with fabric which impregnates resin by prepreping carbon with carbon shaft with the diameter of 18.5mm.

Maxpro provides differentiated concentration and safety for you.

Diameter : 18.5mm

Long Stabilizer	26", 28", 30"
Side Stabilizer	9", 10", 12"
Extender	3", 4", 5"

COLOR



[stabilizer + damper + weight head]

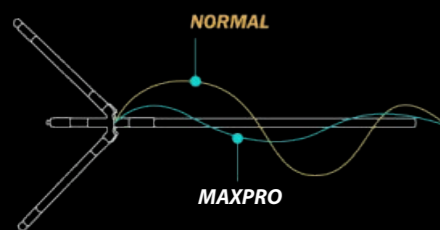

Check over the Vibration (Up and Down)

TECHNOLOGY



[SMX-L]



[SMX-S]



SM740 CUSHION PLUNGER

BTX coating which minimizes the frictional force in the end of the pressure point extends life. Internal design of the micro adjusting device and aeromechanical design which minimizes the effect of the wind. The smooth and simple and easy control system.

Thread : 5/16" - 24
Adjustable Length : min 19.5mm, max 26.5mm
COLOR
Black Silver Blue Red Pink



SM540 CUSHION PLUNGER

Minimizes the gap by removing movement which is unnecessary for the pressure point. BTX coating increases precision by make the frictional force and strength of tension uniform.

Thread : 5/16" - 24
Adjustable Length : min 19.5mm, max 26.5mm
COLOR
Black Silver Blue Red Pink



TC REST

Height adjustable high-end stainless steel rest. Durable construction for precise and secure positioning.

LH
RH



MR REST

Solid design for zero tolerance of error in position and angle. Stainless steel ensured durability while reducing friction.



PR REST

Durable, inexpensive Beginner rest



NEW
CEX2000 WEIGHT

When the exiting weights were used, they could not help supporting bows on ground unstably before set-up because they slipped and the angles of the ground were different from those of the weights. CEX2000 Weight can be connected to more convenient set-up by adjusting support angles of weights to the ground by supplementing this problem.

Diameter : 23mm

TECHNOLOGY 



[WT-CX1] thickness : 11.8 Weight : 30g	[WT-CX2] thickness : 21.0 Weight : 60g	[WT-CX3] thickness : 30.0 Weight : 90g	[WT-CX4] thickness : 39.0 Weight : 120g	[WT-CX5] thickness : 48.5 Weight : 150g	[WT-CX6] thickness : 57.4 Weight : 180g
--	--	--	---	---	---

NEW
AL COLOR WEIGHT

FIVICS Color Weight makes you choose various colors to meet your individual personality by the high quality anodizing coloring.

Diameter : 23mm, 20mm
Material : Aluminum+Stainless

COLOR



[WT-AL1] Diameter : 23mm Weight : 44.3g	[WT-AL2] Diameter : 23mm Weight : 25g	[WT-AL3] Diameter : 20mm Weight : 31.5 g	[WT-AL4] Diameter : 20mm Weight : 18.2g
---	---	--	---



CONNECTING WEIGHT

Connecting weights can connect weights that each size is different from each other to each other. The thicknesses of projecting screws and groove screws are different from each other. So realization of many forms can be done.



 [WT-C1] Diameter : 23mm Weight : 38g	 [WT-C2] Diameter : 23mm Weight : 56g	 [WT-C3] Diameter : 23mm Weight : 36g
---	--	---

WT SERIES



[WT-F] Diameter : 20mm Weight : 26g	[WT-S] Diameter : 20mm Weight : 22g	[WT-H] Diameter : 20mm Weight : 40g
---	---	---

WTC SERIES

WTC
Thread Size : 1/4-20 UNC
Size : 38mm(5T/3T) , 24mm(5T/3T)



[WTC-F1] Diameter : 38mm thickness : 3T	[WTC-F2] Diameter : 38mm thickness : 5T	[WTC-F3] Diameter : 24mm thickness : 3T	[WTC-F4] Diameter : 24mm thickness : 5T
---	---	---	---



GEAR 2000 WEIGHT

TECHNOLOGY 



[WT-GE2] Diameter : 35mm Weight : 85g	[WT-GE3] Diameter : 35mm Weight : 95g
---	---

WEIGHT DAMPER

Cushions the impact between weights and prevents them from loosening. You can express your own personality by choosing various colors of colorful rings.

COLOR



TECHNOLOGY





NEW

TOP SAVER

LIMBS DAMPER SYSTEM

IDEA

Patent Pending

FRONT

BACK

Weight : Front 5.7g / Back 4.7g

TECHNOLOGY

Non Vibration

Absorption of vibration

Non Vibration

[LS-TS]

The existing limb savers have been used by installing the middle parts of limbs. So it was not enough to control vibration in the part which is far from the point that it starts. FIVICS got to develop the top saver that the recurve part can immediately control vibration the limb that it starts. FIVICS' top saver optimized the unnecessary of shooting as it can fast control 50% of vibration of the limbs. Fast control of vibration of the limbs provides faster speed for arrows. FIVICS' top saver removes string's movement and vibration as it is installed in the part which contacts it. The top saver's groove angle accurately and stably supports the recurve part of the limbs and the string's angle.

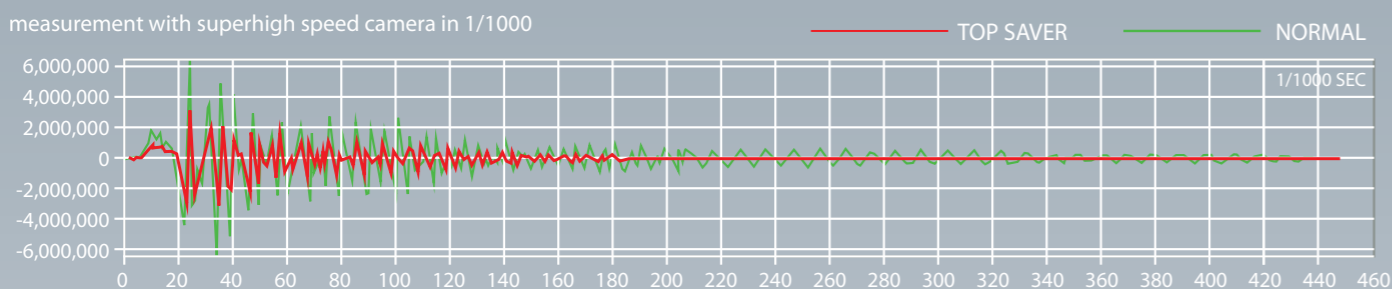

NEW

CEX2000 DAMPER

It's the material which was independently developed by FIVICS' research and development for a long time. BTR300 is innovative for controlling more than 60% of vibration compared to the existing rubber buffer. BTR300 was developed by mixing FIVICS' own new rubber materials and resin with each other and we are confident that it's the best product for cushioning the impact. BTR300's external ring can control the vibration speed faster by playing the role of controlling vibration from the inside again in the outside.

COLOR

Red Yellow Green Blue White

measurement with superhigh speed camera in 1/1000

TECHNOLOGY

Double Core

[VZ-CX20]

V-ZERO synthetic rubber used in FIVICS' buffer was developed by mixing it with the materials which is now used in aerospace . V-ZERO synthetic rubber is very excellent for vibration and noise.

VZ 2000 DAMPER

Fit any stabilizers. Eliminates noise at inside bolt. Best damper absorption system



VZ 1500 DAMPER

Designed to fit any stabilizer. Best V-ZERO damping system. No noise with rubber bolt inside.



UPGRADE
TOP UPSTABILIZER TNS SET

Versatile vibration reduction system design and material
Available in a variety of colors

TNS 100AL / TNS 50AL COLOR



TNS 1000 / TNS 500 COLOR



SQ EXTENDER

It was designed to wrap the internal stainless bar with rubber and to form the aluminium cap on the external wall.

It is very much used in compound bows because it cushions the impact and the safety of weight is high.

Weight : 155g

COLOR



TNS 300

TNS 300SET : TNS 300 + V-Zero damper + weight head



NEW
CEX 2000 UPSTABILIZER

COLOR



TECHNOLOGY



N-SHOCK DAMPER

N-Shock damper by BJD technology uses the slogan, "NO SHOCK", "NO VIBRATION", "NO NOISE" perfectly matched with all stabilizers from FIVICS.

Size : 39 x 20 x 20mm

Material : Aluminum, Rubber

Weight : 24g

COLOR



UPGRADE
TNV 2200, 2300



TNV 1500, 1600



NEW
RB CONNECTING BOLT

Please feel more advanced and smoother shooting!!

There is vibration in the connecting bolt which connects V bars to stabilizers.

FIVICS installed BTR300 in the connecting bolt that blocks reduction of vibration.

TECHNOLOGY



MAN V-BAR
Angle: 40° / 45°



COLOR
Black Silver Blue Red Purple

[VB-M]

RF V-BAR

Light and durable.
A perfect combination
for balanced shooting

Angle: 40° / 45°
Weight: 75g
(Connecting bolt included)

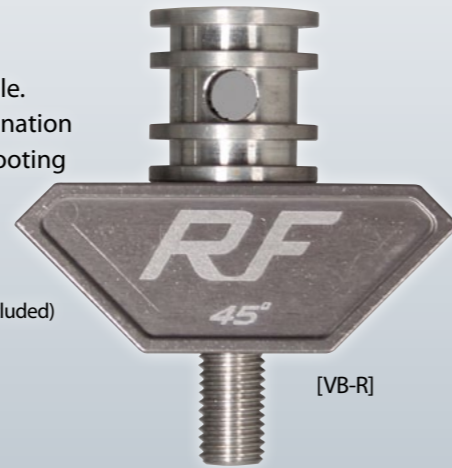

[VB-R]

COM ADJUSTABLE OFFSET SIDE MOUNT

Fully adjustable offset side mount,
Solid machined aluminum
Adjustable angle measurement
system

Color: Black
Material: Aluminum



[CO-AC]

TR V-BAR

Adjustable 360
Horizontal and vertical adjustable system
Easy to use

Color: Dark Grey
Material: Aluminum

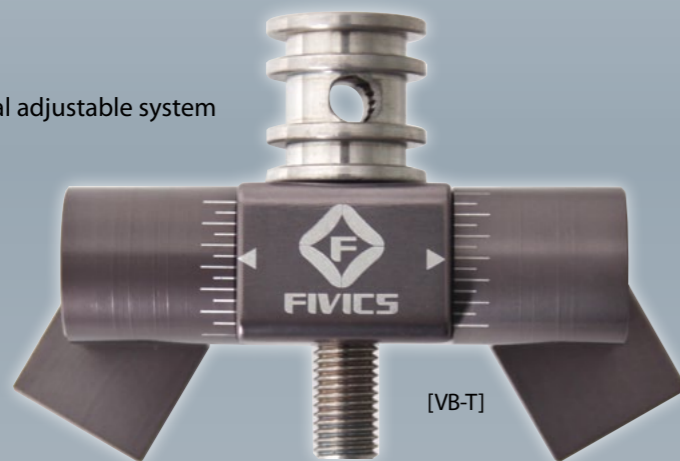

[VB-T]

UNI-BAR



[UNI]

DP V-BAR

The system controls balance of
left/right weights

Angle: 40° / 45°



[VB-D]

TRS V-BAR

The system to transfer front/back
energy

Angle: 40° / 45°



[VB-TR]

TRI V-BAR

The system controls
balance of upper/lower
weights

Angle: 40° / 45°



[VB-V]

COM CONNECTING BOLT

A much better connecting bolt that gets
long stabilizers 10 degrees lower, absorbs vibration
Easy and quick detach system

+ 10Degree Lower



Color: Black
Material: Aluminum



[CA-C]



TECHNOLOGY



It is no exaggeration to say that finger tabs are most important in equipment which most affects record in archery competitions. Consistent distribution of the force and maintenance of balance are absolutely required ranging from hooking to releasing to increase the accuracy rate of arrows due to accurate shooting.

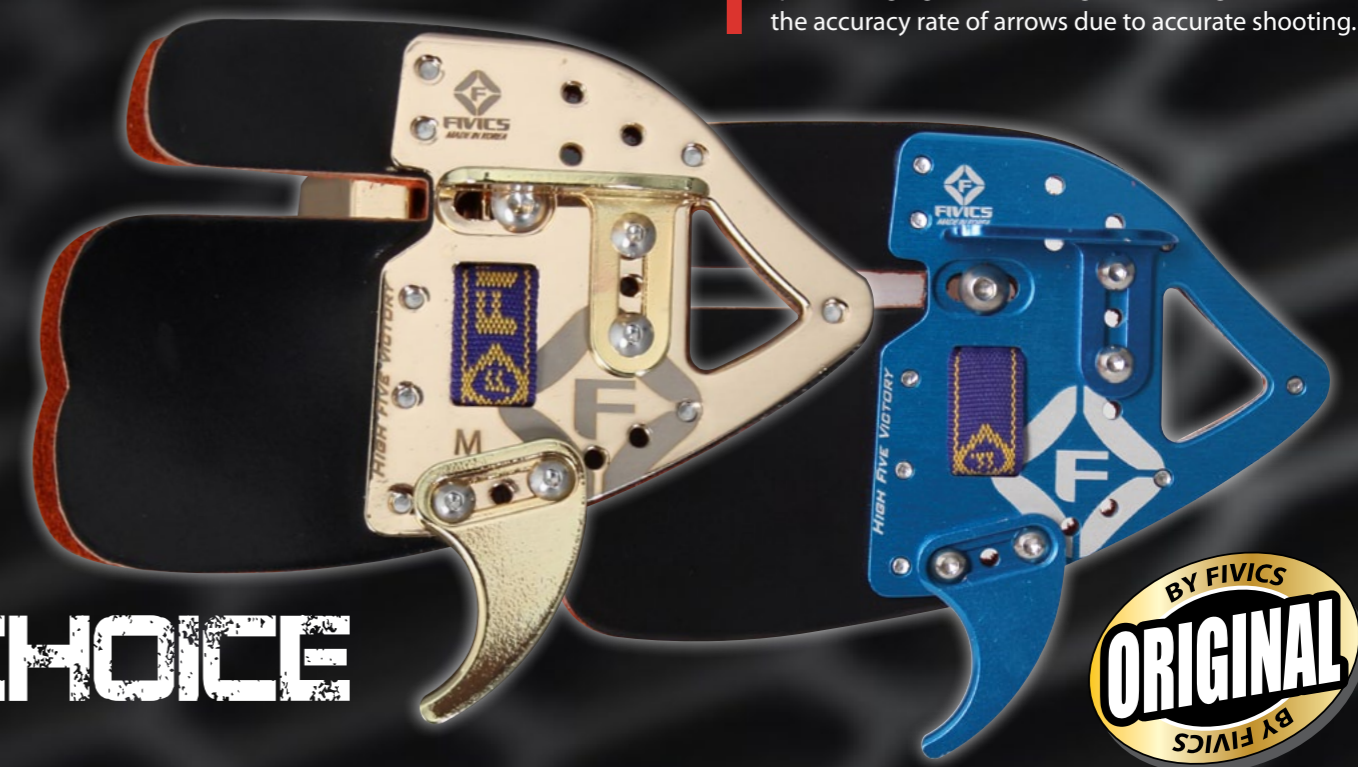

TOP SHOOTER'S CHOICE

NEW

POLITE SERIES



1. The most excellent quality finger tab in the world.
2. Emphasizes the sense of unity in your hands.
3. Absolute stability, accuracy, and sense of unity of hooking
4. 5 Distribution and support of the optimal force by using the whole fingers
5. Ergonomic 3D design
6. Aluminium & anodizing surface treatment
7. The best quality leather "G3 SYSTEM" G1- High Quality Cordovan, G2-Hyperon, G3 Cowhide leather (NEW G2 hyperon rubber is the waterproof sheet and has excellent performance for preventing slip between leathers and protecting fingers.)

FIVICS MISSION NO.1

- * The finger tab makes archers use bows to be the sense of unity as it distributes fingers' force in hooking properly by using the whole fingers.
- * The finger tab makes you be able to draw bows' string stably by using the whole fingers.
- * The finger tab improved arrows' shooting accuracy as the thumb follows the direction to shoot arrows.
- * The finger tab is more table as the little finger can be the supporter and the unnecessary force is not used.
- * The sense of unity, weight, thickness, adhesion of palms, stability of curves, anchor ring's constancy.

FIVICS MISSION NO.2

The finger tab for archery facilitates the movement to draw and release strings of bows by using two fingers (an index finger and a middle finger). You should release a string by moving your index finger, middle finger, and ring finger equally in the movement to release the string to make shooting be good. Your middle and ring fingers are put on the tab in the lower part together. But your ring finger is shorter than your middle finger and the lesser part that your ring finger is put on the string of a bow than your middle finger. In many cases, archers who are not good at games or are nervous during the games strum or scratch strings in the movement to release them. Therefore, the strings of the bows are shaking from side to side. So the paradox phenomena (As arrows fly, they are bended from side to side.) get to occur more frequently as repulsion about this. Eventually, arrows escape from aiming points of targets. This invention was designed to draw and release strings by using your index and middle fingers only and apply the force by your ring and little fingers effectively so that the finger tab for archery to be able to shoot arrows accurately and distribute the force effectively can be provided for you. It prevents mistakes by using ring fingers by making you draw and release strings with your index and middle fingers only. On the other hand, this invention makes you shoot arrows by using the whole fingers effectively, not doing them with your index and middle fingers only. And it provides the finger tab of the compact structure which can support your chin while you put your thumb on your bow and hold it for you. As the invention enables you to shoot arrows accurately, there is the effect to make archers show the best skills.

POLITE 3 CARE



POLITE 2 CARE

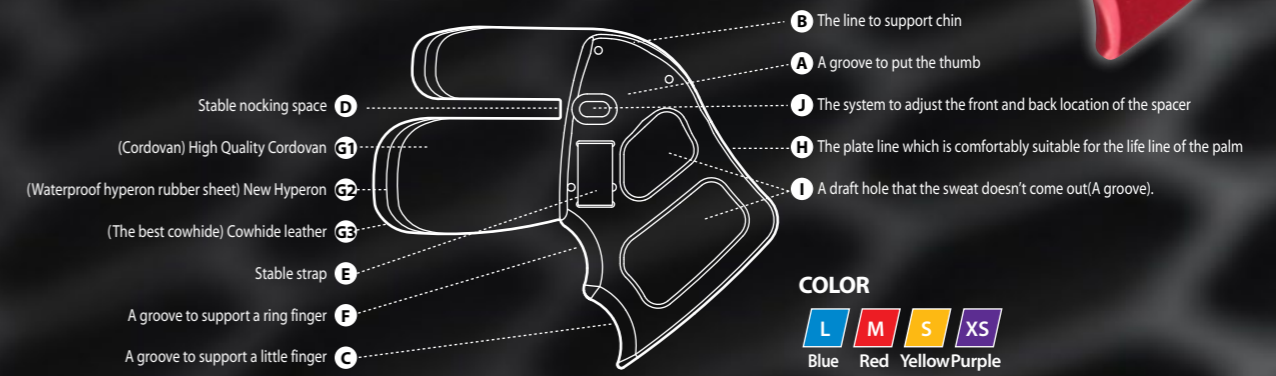
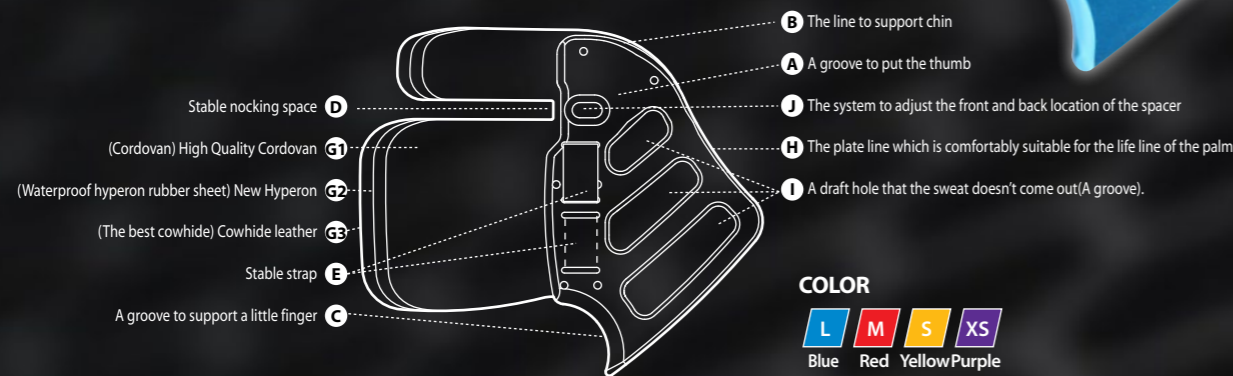

TECHNOLOGY



TECHNOLOGY

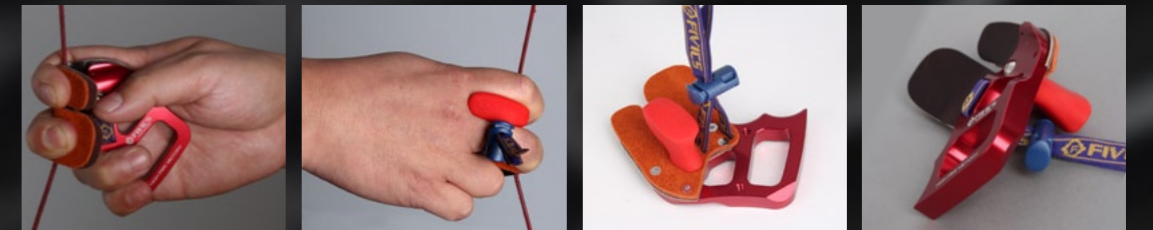

SAKER

BY FIVICS
ORIGINAL
SIAH 2018

Ergonomic design
Adjustable ledge
Replaceable face and backing
Optional finger spacer available

Find your relative shared power balance of your fingers!

What do you think of the most effective equipment on shooting?
There is a finger tab which is the most effective equipment than others.
Here is the solution for more accurate shot and constant shot!



SAKER1



SAKER2



SAKER3

UPGRADE
BRASS SAKER 1

Size : L / M / S (RH / LH)
Weight: L 162g, M 152g, S 144g
Leather : Cordovan



[BSK-01-A]

UPGRADE
BRASS SAKER 2

Size : L / M / S (RH / LH)
Weight: L 150g, M 140g, S 136g
Leather : Cordovan



[BSK-02-A]

UPGRADE
BRASS SAKER 3

Size : L / M / S (RH / LH)
Weight: L 130g, M 128g, S 112g
Leather : Cordovan



[BSK-03-A]

NEW
CARBON SAKER 1

Size : XL / L / M / S / XS / XXS (RH / LH)
Leather : Cordovan



[C-SK-1]

NEW
CARBON SAKER 2

Size : XL / L / M / S / XS / XXS (RH / LH)
Leather : Cordovan



[C-SK-2]

NEW
CARBON SAKER 3

Size : L / M / S (RH / LH)
Leather : Cordovan



[C-SK-3]

SAKER 1

Size : XL / L / M / S / XS / XXS (RH / LH)
Leather : Cordovan

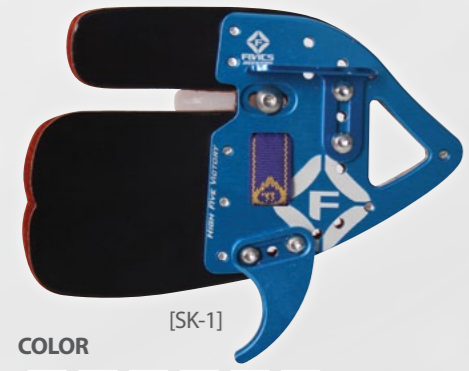

[SK-1]

COLOR
XL L M S XS XXS
Dark Blue Blue Red Yellow Purple Dark Green

SAKER 2

Size : XL / L / M / S / XS / XXS (RH / LH)
Leather : Cordovan



[SK-2]

COLOR
XL L M S XS XXS
Dark Blue Blue Red Yellow Purple Dark Green

SAKER 3

Size : L / M / S (RH / LH)
Leather : Cordovan



[SK-3]

COLOR
L M S
Blue Red Yellow

UPGRADE
SAKER 1 FINGER TAB FRAME EP

FB-EP only fit Saker 1 finger tab
It offers top shooters another value for their hooking direction, comfortable and balanced.
This component enhances the saker finger tab's Ergonomic design



Size : saker1 XL , L = EP (L size)
saker1 M , S = EP (M size)
saker1 XS , XXS = EP (S size)

CORDOVAN TAB

Functional with hand protected cordovan leather
Light and soft



[PR-200]

The best leather with the history of 100 years by American HW is used in FIVICS' cordovan.

FINGER SPACER



[FS-F]

NEW
Material : Rubber
Size : 39.8 x 29.3 x 16.2mm
Weight : 14g
COLOR

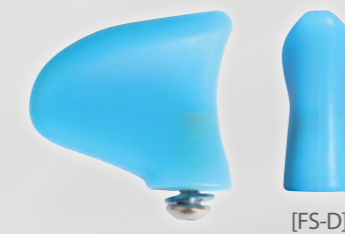

[FS-D]

Material : Rubber
Size : 32 x 28 x 12.4mm
Weight : 10g
COLOR



[FS-A]

Material : Plastic
Size : 36 x 28.3 x 12.3mm
Weight : 8g



[FS-E]

Material : Brass
Size : 36.3 x 27.3 x 10.2mm
Weight : 56g



[FS-C]

Material : Aluminum
Size : 35.5 x 26.4 x 10mm
Weight : 18g



[FS-B]

Material : Rubber
Size : 37.4 x 26 x 11.5 mm
Weight : 12g

NEW

Gear FIVICS

FIVICS' hunting series, "Gear FIVICS" is ambitiously released by FIVICS, the innovative company in the archery world by receiving various needs of hunters for a long time and introducing FIVICS' innovative elements. We prepared this very painstakingly and with many ideas so that each shot can be the best shot by insight that we think a few steps ahead even in the rapidly changing situations.
Gear FIVICS The Best Shot

G009 HUNTING QUIVER

It is light by considering hunters' activity And it was designed to be most convenient and stable.

Size : 14.9"(width) x 19.2 (height) x 2.95 (thickness)

TECHNOLOGY



Belt included



G007 HUNTING QUIVER

Prevents vibration of quiver by considering hunters' momentary activity.

Belt size : 32" ~ 40" (M)
36" ~ 44" (L)



[G09-Q5]

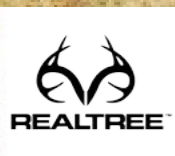

[CC-1200]

[CC-980]

G1200 COMPOUND SOFT CASE

A 1200 mm-long compound bow case's function to protect bows is excellent as the thickness of the form which protects them on the outside is about 10t.

And it is very convenient to carry it when you move because their placement is simple and there is space for accessories and quivers.

Size : 47" Pocket : 2pcs

G980 COMPOUND SOFT CASE

A 980 mm-long compound bow case's function to protect bows is excellent as the thickness of the form which protects them on the outside is about 10t.

And it is very convenient to carry it when you move because their placement is simple and there is space for accessories and quivers.

Size : 38" Pocket : 2pcs

G30 COMPOUND BAG

The strong high quality materials were used.

The location and size of storage space are convenient and there is space for laptop and computer accessories in the inside.

It was designed to minimize stress of your shoulders even when you move for a long time.



[BP-G30]



[TK-G5]



The Best Shot

UPGRADE

THUNDER SERIES

RECURVE & FIELD

The strong high quality materials were used. The location and size of storage space are convenient. It is very convenient when you move as convenient storage space and pockets for clothes and accessories are secured in the inside. There are a quiver and a rain cover used when it rains in it. Wheels can be changed. You can use it more conveniently when you move for a long time as there is a shoulder strap.



CCD 1250

- Upgraded handle to carry
- Protect compound bows with a durable fabric and angled case
- Extra pockets for accessories
- Convenient to carry
- Easy transportation system with strong wheels
- Interchangeable wheels
- Room for two compound bows

Dimension : 15" x 45" x 12"

CCS 1250

- Protect compound bows with Durable fabric and angled case
- Extra pockets for accessories
- Convenient to carry
- Easy transportation system with strong wheels
- Interchangeable wheels
- Room for one compound bow

Dimension : 15" X 45" X 6.5"



[CPC-T]

[CPC-TS]



Pocket+Arrow tube + Rain cover included

RCD 930

- Convenient to carry
- Easy transportation system with strong wheels
- Interchangeable wheels
- Room for two recurve bows

Dimension : 14" X 36.5" X 12"

RCS 930

- Convenient to carry
- Easy transportation system with strong wheels
- Interchangeable wheels
- Room for one recurve bow

Dimension : 14" X 36.5" X 7"



Arrow tube + Rain cover included



[RCC-700]

[RCS-700]

UPGRADE

AEGIS HARDCASE

High quality hardcase
This model can hold up to two recurve bows and their accessories

Size : 33" X 15" X 10"

Material : ABS

Pocket : 1 pcs

COLOR



TECHNOLOGY

pass customs



Shock alleviation

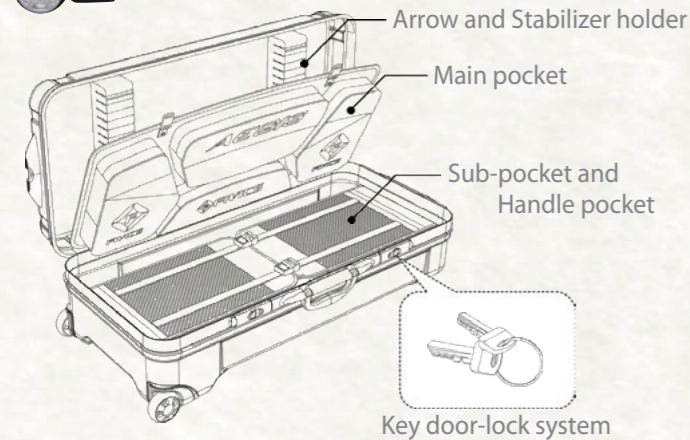

Rain cover / Case belt included

TENTRON
— SERIES —



[BP-C1]

TENTRON-M BACKPACK

Special design that the best fabric is used by selecting it.
There is space that 1 Set Bow can be conveniently stored and selection of the location is effective.

Size : 11.8" X 7.8" X 26.7"

Pocket : 1 pcs

COLOR

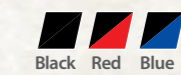

- Arrow tube
- Equipment case
- Riser & Limbs case included



[BP-C2]

UPGRADE
TENTRON-P BACKPACK

There is space that 1 Set Bow can be conveniently stored and selection of the location is compact.

Size : 11" X 7" X 26"

- Arrow tube
- Riser & Limbs case included

TENTRON-J
BACKPACK

The strong high quality materials were used. The location and size of storage space are convenient and there is space for laptop and computer accessories in the inside.

It was designed to minimize stress of your shoulders even when you move for a long time.



NEW
TENTRON-Q BACKPACK

It is easy to move by putting quiver and accessories in this back pack conveniently when archers move from stadiums to lodgings,

UPGRADE

X TROLLEY BACKPACK SERIES

Trolley bag
Well-arranged pockets
Room for one bow and accessories

TECHNOLOGY

- Human engineering
- Water proof
- Perfect Line
- Human engineering
- Elasticity



X-500 TROLLEY BACKPACK

Dimension : 27"x13.5"x9"



[TB-2]

[TB-1]

X-300 TROLLEY BACKPACK

Dimension : 22"x13"x8"



[TB-BB]

TRAVEL BIGBAG TROLLEY BACKPACK

It is very convenient to use it as you can pull it and carry it on your shoulders because storage space for shoes, clothes, etc. is well arranged.



[CPC-3]

[CPC-2]

UPGRADE V-STORM CC COMPOUND BOW CASE

Simple and convenient design with the best quality.
The best elastic interior padding
Keeps the bow safe
Simple arrangement with two outer pockets

Size : 38", 47" Pocket : 2pcs

UPGRADE V-STORM RC 500 RECURVE BOW CASE

Size : 36" Pocket : 2pcs



[RCC-500]



[BP-C4]

CO-STAR BACKPACK

Stylish hybrid backpack



COLOR



- Arrow tube
- Equipment case
- Riser & Limbs case included



TOOL BOX SOFT CASE

Three plastic cases included for tools such as Nocks, points, rests, vanes, wrench sets etc.
One front zip pocket
Adjustable shoulder strap
Strap Padding included for shoulder safety
Easy to carry



[TB-7]

EQUIPMENT CASE

Well-arranged and slim design fits all equipments inside (sight, short stabilizer, extender, v-bar, wrench set etc)

Size : 15.5" X 9"

COLOR



[EC-09]

STABY CASE

Case for full stabilizer set



[SC-10]

COLOR



3LEVELS FOLDING BOW CASE

Innovative design : Very easy to carry your Complete set of equipment.

COLOR



[SC-11]



RISER FOAM CASE

Interior padding



[RS-CS1]

LIMBS FOAM CASE

Interior padding



[LM-CS]

RISER & LIMBS CASE



[LR-CS]

UNITON-Y

Handy small zip-pocket in front
1 large main zip
Casual sporty bag

COLOR



[TB-5]

NEW UNITON-M

Casual sporty back pack



[TB-7]

UNITON-G

Casual sporty back pack



[TB-4]

NEW UNITON-C

Casual and sporty briefcase and computer briefcase



[TB-6]

NEW
UNICO FIELD QUIVER

It is lighter as the best artificial leather is specially manufactured to be suitable for quiver for archery. And it improved convenience of use by minimizing vibration and simple design.

Belt size : 32" ~ 40" (M)
36" ~ 44" (L)
Weight : 418g
RH / LH



COLOR
Navy Beige Red

[UN-Q]

ACCENDO TOURNAMENT
QUIVER

Light weight (630g)
Large pocket for accessories
Upgraded belt material
For T-gauge
Pen holder
Record carrier
Fancy design

Size : 14.9"(width) x 19.2 (height)
x 2.95 (thickness)
Belt size : 32" ~ 40" (M)
36" ~ 44" (L)
Weight : 630g
RH / LH

COLOR
Black Blue Red Green Pink



[AC-Q]

ACCENDO BACK
QUIVER

Light weight (260g)
Colorful design
Artificial leather
Pen holder
Record carrier

Belt size : 32" ~ 40" (M)
36" ~ 44" (L)
RH / LH

COLOR
Black Blue Red Green Pink



[AC-QM]

XK QUIVER

Colorful design
Artificial leather
Pen holder
Record carrier

Belt size : 32" ~ 40" (M)
36" ~ 44" (L)
RH / LH

COLOR
RED Orange Blue



[XK-Q]

MIRACLE 500
QUIVER

Double pocket system
High performance line

Belt size : 32" ~ 44"
RH / LH

COLOR
Black Silver Blue Red Orange



[MC-05]

FREENIC PLUS
QUIVER

Upgraded stylish design
Simple and durable

Belt size : 32" ~ 44"
RH / LH

COLOR
Black Silver Blue Red Orange



[LS-Q3]

NURI QUIVER

Pockets for wrench set
Room for all accessories

Belt size : 32" ~ 40" (M)
36" ~ 44" (L)
RH / LH

COLOR
RED Orange Blue Black



[AM-1]

MIRACLE 300
QUIVER

Multiple fashionable colors

Belt size : 32" ~ 44"
RH / LH

COLOR
Black Silver Blue Red Orange



[MC-03]

METEOR 500
QUIVER

Simple and light
3 tube design

RH / LH

COLOR
Silver Yellow Green Pink



[MT-Q5]

METEOR 300
QUIVER

Bright color
2 tube design

RH / LH

COLOR
Black Green Blue Red



[MT-Q3]

TK2 HAND POCKET



[TK-A]

TK3 HAND POCKET



[TK-B]

NATIONAL HAND POCKET



[TK-C]

AVAILABLE FOR ANY COUNTRIES

HK EQUIPMENT

HOLDER



[HK-A]

GABO BOW STAND

It is more convenient to use it when spreading and folding its legs as spring systems are installed in the three support legs. Fixation of the grip part is stable. And it was designed to support it safely even though you separate bows from your hands while you don't support string.

Height : 44cm
Material : Aluminum
COLOR



Blcak Silver



[ST-G]

AUTOMATIC

BOW STAND

It's the best product that the telescopic umbrella system is applied in the existing stands.

You can use it fastest and most conveniently when folding and spreading the legs of the stand.

You can adjust the width freely with the fixed frame in the grip part.

Height : 44cm [ST-A], 65cm [ST-B]
Weight : 573g [ST-A], 680g [ST-B]
Material : Aluminum

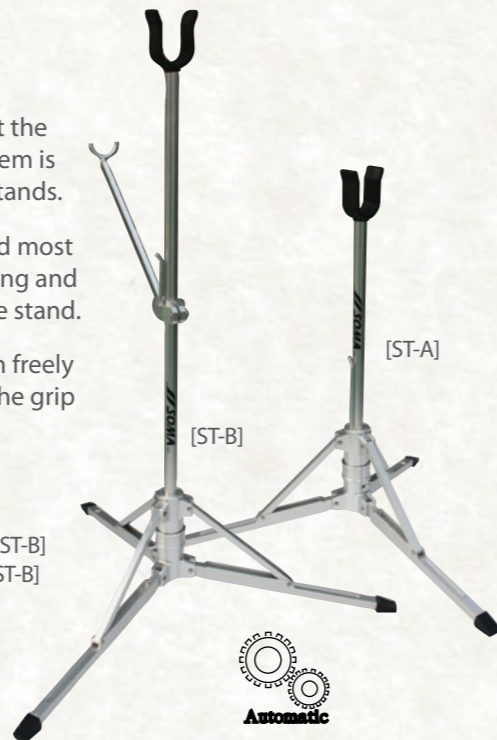

[ST-A]

[ST-B]



FIVICS PULL FOR ALL ARCHERS

Pull of ergonomic design that you can pull out arrows safely and easily.



[AR-P1]

COLOR



Black Blue Red Green

A2 CHEST GUARD

The Chest Guard to adjust sizes are now most conveniently used.

The elastic system to adjust a shoulder band

The button system to adjust sides

SIZE : XL, L, M, S, XS
RH / LH



COLOR



Blcak White Blue Red Yellow Pink

[AP-A2]

SHELTER PLUS NATIONAL

CHEST GUARD

The durability is very excellent as fabric used in NIKE shoes. The wearability is comfortable and the durability of groove in strong net is excellent.

SIZE : XL, L, M, S, XS
RH / LH



[AP-FR]



AVAILABLE FOR ANY COUNTRIES



NEW HARNESS JELL ARM GUARD

Throw out the existing concept of arm guard! A gel arm guard is first released in the world! Harness Gel Arm Guard's wearability is very excellent by using rubber and it has an advantage that it doesn't break.

For Harnes Gel Arm Guard's features, it can reduce shooting by mistakes as it minimizes strings' vibration and repulsion in the moment

they hit it even when the guard is hit by strings.

COLOR

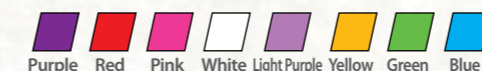

Purple Red Pink White Light Purple Yellow Green Blue

NEW BAND CHEST GUARD

Band Chest Card of ergonomic design provides more stable adhesion for you and prevents touching of strings in shooting by attaching band to the sides. Especially, it was specially designed by considering women's physical characteristics.

SIZE : XL, L, M, S, XS RH / LH



[AP-B1]

TECHNOLOGY



RAINBOW SHIELD ARM GUARD

[SP-R]



COLOR



Blcak White Red Orange Pink Purple Yellow Green SKYBlue Blue

TECHNOLOGY



[AG-HN1]



CARBON T-GAUGE BOW SQUAR

Pliable strong carbon
Easy hang up style



FIVICS STRINGER

Easy to use

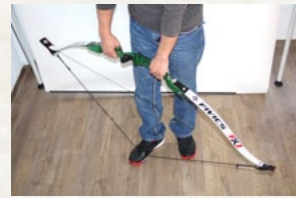

LIMB PROTECTOR

The device to protect the tip part and your feet when setting up bows.

Size : 56X97 mm
Material : Enamel, Rubber



DACRON BOWSTRING

Strings : Meticulously ready made string
RECURVEBOW & TRADITIONAL BOW & CROSS-BOW

Material : DACRON STRING & NYLON SERVING
Serving color : Red/Blue/Green/Yellow/White/Black



STRAFE BOWSTRING

67% SK75 dyneema, 33% vectran
Half the strand size of 450 plus
Slightly higher arrow speed
Higher strand count improves flexibility.
Looks great for multi-colored strings

Recommended strands : 22 / 24
Approx ft / lb waxed : 8800
Speed size : 1lb



SLING

It's soft but uses strong and highly durable material.



QUICK GRIP MARKER

Customize your grip!
Our material gives you a simple and fast solution that can be molded and cut easily for a sure fit to your unique hand. Hardens and is waterproof in 80 minutes.

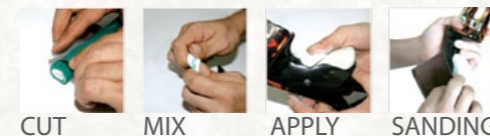

EZ FLETCHER

MULTI-FUNCTION SYSTEM!!

Better accuracy and convenience
Developed stability, certain control system
Perfect balance for every arrow
Holding system for the best set up
Easy to use, ergonomic design

EZ FLETCHER by BJD Technology has Shaft hold system, pincers control system And strength adjustment system



Shaft hold system

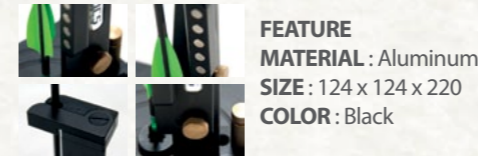

FEATURE
MATERIAL : Aluminum
SIZE : 124 x 124 x 220
COLOR : Black



GRAIN SCALE

LCD digital screen display
15 grain accuracy
Weights- Grains, Grams, Ounces and CWT
Extremely small 5"X3"X3/4"
Lightweight 6 oz

Model : 60200
Description : Electric scale
Inner pack : 3
Case pack : 12



STRETCH BAND

It is excellent for relaxation in games by effective stretching, warming up, and relaxation of muscles

Size : 20m X 15cm X 0.2mm



[LB-L] Yellow

[LB-H] Green

[Metric] Purple Red
[Inched] Blue Yellow

NEW QUICK DRYING GLUE



[GL-50]

[GL-20]

NEW HOTMELT



[GL-HM]

FIVICS ARROW TUBE

[AT-F1]



Model : 60200
Description : Electric scale
Inner pack : 3
Case pack : 12

HEX-I WRENCH

The wrench of simple and compact design. It is convenient to carry it and the durability is excellent.

Material : Aluminum
Weight : 90g
Spec : 1.5 / 2.0 / 2.5 / 3.0 / 4.0 / 5.0



[HAW-2]



[HAW-1]

CLOTHES

Size : S / M / L / XL / XXL



[FT-A]



[FT-B]



[FT-H]



[FT-I]



[FT-F-1]



[FT-F-2]



[FT-G-1]



[FT-G-2]

CAP



[FC-A]

Black White



[FC-B]

NAVY White



[FC-E]

NAVY White



[FC-F]



[FC-C]

NAVY White



[FC-D]

NAVY White



[FC-G]

NEW



[FC-H]

NEW

SOCKS



[SO-A]



[SO-C]



[SO-B]



[SO-D]

ARM SLEEVE



[AR-SL]

UMBRELLA

length : 1m
opened size : 1m 60cm

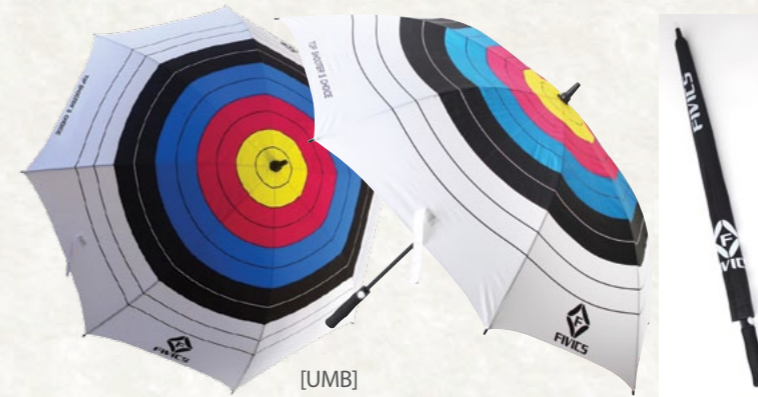

[UMB]

NEW USB

8GB : [USB-8] 16GB : [USB-16]



CLOCK



[CLK]

KIDS BOW SET



[YB-A]



- BOW - 1EA
- QUIVER - 1EA
- SAFETY ARROW - 5EA
- MAGNETIC DART - 6EA
- TARGET BOARD 430mm - 1EA

PHONE RING



[PHR-B]

[PHR-C]

[PHR-A]



FIVICS WATER PROOF TARGET FACE

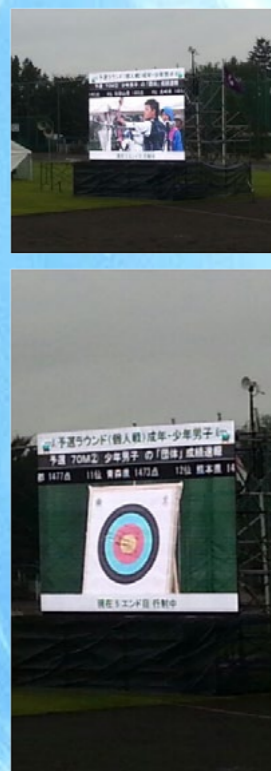

FIVICS Target Face Funtion

[Out Door, In Door, Training, Field]

- + Material : Polyester
- + Thickness : 0.29mm
- + Tensile strength (kg/cm2) : (L- 40.0 / W- 17.0)
- + Temperature range : -32 ~ 260 C
- + Printing error range : 99.9% (Best "Quality")

[Available also in economic Target face in all the range of size]



- + Waterproofing
- + Useable under any weather condition
- + High tensile strength and coherence
- + Little crumpling and tearing
- + Hardly change in the shape and color
- + Allow no light reflection
- + No damage to the score line
- + Favoring environment - availble recycling and safe incineration
- + Safely transportable and manageable, and unnecessary protective equipment

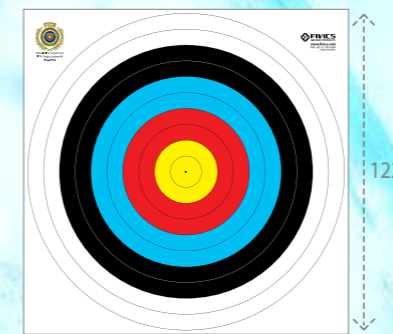

Name : OUTDOOR 122cm Target Face [PT 001]
Range : 90m / 70m / 60m
Mark dimension : 122cm X 122cm
Total dimension : 125cm X 125cm (width/length)



Name : OUTDOOR 40cm-5ring Target Face [PT 005]
Range : 30m / 20m
Mark dimension : 40cm X 40cm
Total dimension : 43cm X 43cm (width/length)



Name : OUTDOOR 48cm-6ring Target Face [PT 007A]
Range : 50m
Mark dimension : 48cm X 48cm
Total dimension : 51cm X 51cm (width/length)



Name : OUTDOOR 80cm Target Face [PT 002]
Range : 50m / 30m
Mark dimension : 80cm X 80cm
Total dimension : 83cm X 83cm (width/length)

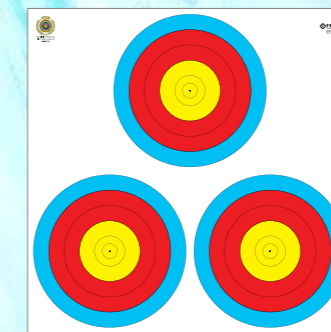

Name : OUTDOOR(3X40W) Triangular Target face(5Line) [PT 006]
Range : 30m / 20m
Mark dimension : (40cm-Center X 3Target)
Total dimension : 85cm X 85cm (width/length)



Name : OUTDOOR(3X48W) Triangular Target face(6Line) [PT 007A3]
Range : 50m
Mark dimension : (48cm-Center X 3Target)
Total dimension : 99cm X 98.5cm (width/length)



Name : OUTDOOR 60cm Target Face [PT 003]
Range : 25m
Mark dimension : 60cm X 60cm
Total dimension : 63cm X 63cm (width/length)

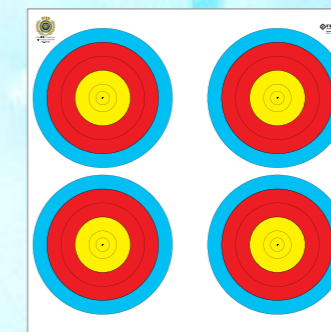

Name : OUTDOOR(4X40w) Target face(5Line) [PT 007]
Range : 30m / 20m
Mark dimension : (40cm-Center X 4Target)
Total dimension : 93cm X 85cm (width/length)

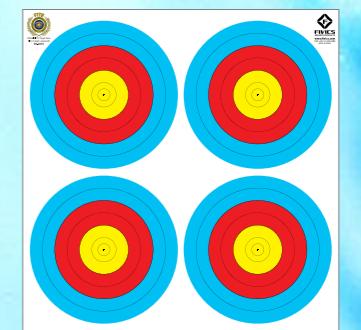

Name : OUTDOOR(4X48W) Triangular Target face(6Line) [PT 007A4]
Range : 50m
Mark dimension : (48cm-Center X 4Target)
Total dimension : 102cm X 105cm (width/length)

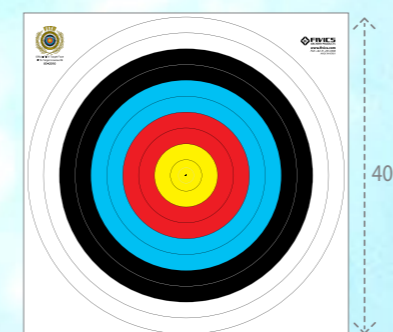

Name : OUTDOOR 40cm Target Face [PT 004]
Range : 18m
Mark dimension : 40cm X 40cm
Total dimension : 43cm X 43cm (width/length)

OUT/INDOOR TARGET FACE



ASIA FIRST FITA TARGET FACE LICENSED MANUFACTURER

INDOOR TARGET FACE

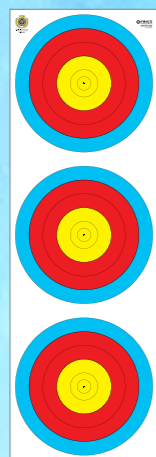

Name: INDOOR 20cm(3X20W)
Target Face(18m) [PT 008]
Range: 18m
Mark dimension: 20cm X 3 Target
Total dimension: 23cm X 67cm
(width/length)



Name: INDOOR (4X40cm) Single Target Face [PT 009]
Range: 18m
Mark dimension: 40cm X 4 Target
Total dimension: 93cm X 85cm (width/length)

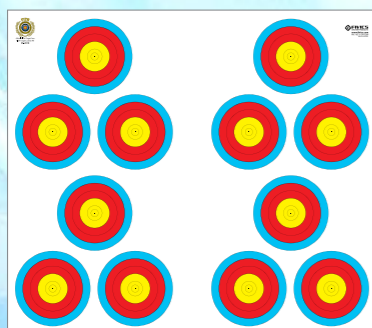

Name: INDOOR 20cm Triangular Triple Target Face [PT 011]
Range: 18m
Mark dimension: 20cm X 3 X 12 Target
Total dimension: 97cm X 85cm (width/length)

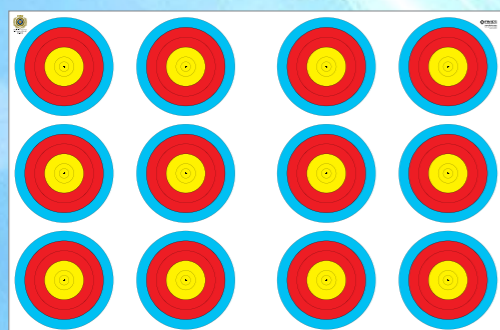

Name: INDOOR 12cm(3X20W) Target Face(18m) [PT 010]
Range: 18m
Mark dimension: 20cm X 12 Target
Total dimension: 103cm X 67cm (width/length)

TRAINING TARGET FACE



Name: TRAINING 80cm-CenterSpot Target Face(8Line) [PT 012]
Range: 50m/30m/20m
Mark dimension: 24cmX24cm
Total dimension: 32cmX32cm(width/length)



Name: TRAINING 122cm-CenterSpot Target Face(7Line) [PT 013]
Range: 90m/70m/60m
Mark dimension: 48.8cmX48.8cm
Total dimension: 61cmX61cm(width/length)

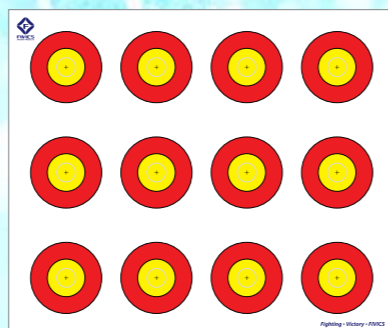

Name: TRAINING Target Face [PT 020]
Mark dimension: 52mmX52mm
Total dimension: 282mmX238mm(width/length)

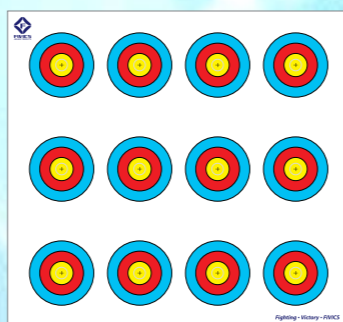

Name: TRAINING Target Face [PT 021]
Mark dimension: 48mmX48mm
Total dimension: 250mmX231mm(width/length)

FIELD TARGET FACE



Name: FIELD 80cm Target Face [PT 014]
Mark dimension: 80cmX80cm Target
Total dimension: 83cmX83cm(width/length)



Name: FIELD 60cm Target Face [PT 015]
Mark dimension: 60cmX60cm Target
Total dimension: 63cmX63cm(width/length)

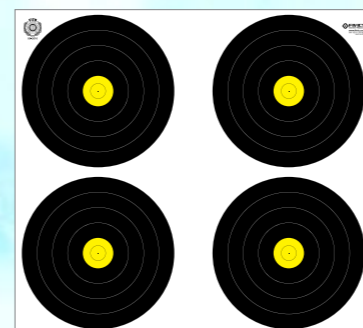

Name: FIELD 40cm(4X40W) Target Face [PT 016]
Mark dimension: 40cmX40cm
Total dimension: 93cmX85cm(width/length)

ACADEMIC TARGET FACE



Name: OUTDOOR Target Face [PT 017]
Range: 70m
Mark dimension: 97.2cmX97.2cm
Total dimension: 103cmX103cm(width/length)

STICKER TARGET FACE

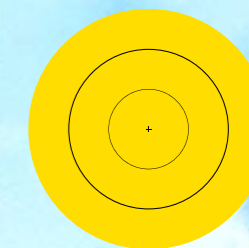

Name: Sticker Target Face [PT 018]
Range: 90m / 70m / 60m
Mark dimension: 15.8cm X 15.8cm



Name: Sticker Target Face [PT 019]
Range: 50m / 30m
Mark dimension: 24.3cm X 24.3cm

PERFECT SCORE SHEET



Name: Perfect score sheet
Total dimension: A4(21 X 29.7)
Applicable under any weather condition
Ink not smudged



ASIA FIRST FITA TARGET FACE LICENSED MANUFACTURER



PRO STAFF

TEAM CHINA CUI Yuanyuan

• 2013 Archery World Cup Stage 2 in Antalya (TUR)

GOLD

• 2013 Archery World Cup Final in Paris(FRA)

BRONZE

• The 12th National Games of The People's Republic of China

DOUBLE GOLD

2013 CONGRATULATIONS

CONGRATULATIONS!
GOLD MEDAL in Archery World Cup 2013 Stage 2 Antalya (TUR)

CUI Yuanyuan
CHINA

Gold Medal

FIVICS TOP SHOOTER'S CHOICE

CONGRATULATIONS

HE USES
FX1 LIMB

GOLD MEDAL
THE NATIONAL GAMES TAIPEI 2013

FIVICS TOP SHOOTER'S CHOICE

CONGRATULATIONS

GOLD MEDAL
BERLIN OPEN INTERNATIONAL ARCHERY MEETING 2013

HE USES
SAKER 1 FINGER TAB FRAME EP

FIVICS TOP SHOOTER'S CHOICE

CONGRATULATIONS
30m 360 PERFECT SCORE!

제 45회 전국남여양궁합선수권대회(2013년 국가대표 1차 선발전)

구본환 김규찬

FIVICS PERFECT WATER PROOF TARGET FACE

CONGRATULATIONS

CUI Yuanyuan

SHE USES
FX1 LIMBS
CE20000 STABILIZER SET
WEIGHT DAMPER
HQ ARM GUARD
SE-4 CHEST GUARD
ACCENDO BACK QUIVER
SAKER FINGER TAB
TK2 HANDPOCKET

Bronze Medal
2013 ARCHERY WORLD CUP FINAL IN PARIS(FRA)

FIVICS TOP SHOOTER'S CHOICE

Gold Medal

TOP SHOOTER'S CHOICE
CONGRATULATIONS!!
제24회 한국실업연맹회장기대회 남자개인전 우승

이종영

FIVICS

CONGRATULATIONS
20M 360 PERFECT SCORE!

5th grader in Chokseok elementary school
KIM SEON WOO

2013 THE 24th Korean national elementary school archery competition

FIVICS

CONGRATULATIONS

CUI Yuanyuan

SHE USES
FX1 LIMBS
CE20000 STABILIZER SET
WEIGHT DAMPER
HQ ARM GUARD
SE-4 CHEST GUARD
ACCENDO BACK QUIVER
SAKER FINGER TAB
TK2 HANDPOCKET

DOUBLE Gold Medal
The 12th National Games of The People's Republic of China

FIVICS TOP SHOOTER'S CHOICE

2013 TRIPLE FITA COMPETITION
TOP SHOOTER'S CHOICE

Winner

HE USES
SAKER 1 FINGER TAB FRAME EP

FIVICS

CONGRATULATIONS!!
GOLD MEDAL in 2013 Archery World Cup Stage 4 Wroclaw (POL)

LEE Seungyun

HE USES
SAKER 1 FINGER TAB FRAME EP

FIVICS

For more information visit us online at www.fivics.com.

THE FIVICS QUEST FOR PERFECTION IS ON-GOING.



Tel: 82-31-245-6389 **Fax:** 82-31-245-6386 **E-mail:** info@fivics.com
Address: 876 Gyeongsu-daero Jangan-gu Suwon-si Gyeonggi-do Korea

www.facebook.com/fivics.korea
www.youtube.com/fivickorea

